

NATIONAL AMBIENT AIR QUALITY MONITORING  
SERIES : NAAQMS/ ... /2003-04

# Guidelines for Ambient Air Quality Monitoring



**CENTRAL POLLUTION CONTROL BOARD  
MINISTRY OF ENVIRONMENT & FORESTS**

Website: [www.cpcb.nic.in](http://www.cpcb.nic.in)  
e-mail: [cpcb@alpha.nic.in](mailto:cpcb@alpha.nic.in)

**April, 2003**

NATIONAL AMBIENT AIR QUALITY MONITORING  
SERIES : NAAQMS/ ... /2003-04

# **Guidelines for Ambient Air Quality Monitoring**



**CENTRAL POLLUTION CONTROL BOARD**  
(Ministry of Environment & Forests, Govt. of India)  
Parivesh Bhawan, East Arjun Nagar  
Delhi – 110 032  
e-mail : [cpcb@alpha.nic.in](mailto:cpcb@alpha.nic.in) Website : [www.cpcb.nic.in](http://www.cpcb.nic.in)

CPCB 200 Copies, 2003

---

Published By : Dr. B. Sengupta, Member Secretary, Central Pollution Control Board, Delhi - 32  
Printing Supervision & Layout : P.K. Mahendru and Satish Kumar  
Composing & Laser Typesetting : Mohd. Javed  
Printed at : National Institute of Science Communication (CSIR), New Delhi

## CONTRIBUTIONS

Guidance, Report Review and Finalisation :	Dr. B. Sengupta
Coordination and Supervision :	Dr. R.C. Trivedi Sh. R.C. Saxena
Report Preparation :	Sh. Naresh Badhwar Dr. (Mrs.) Rekha Sitaswad
Measurement Methods :	Dr. S.D. Makhijani Sh. J.S. Kamyotra Dr. M. Q. Ansari Sh. Gurnam Singh Dr. S. Philip Dr. R.C. Srivastava Dr. Sanjeev Agarwal Sh. M. Satheesh Kumar Sh. Ved Prakash Sh. Aditya Sharma Sh. K. Karunakaran Sh. Rajinder Singh Sh. Surinder Singh Sh. S.K. Sharma Smt. Anju Bhardwaj Sh. Vasu Tiwari
Drawing :	Sh. Suraj Mal Sh. R.S Shahi Sh. Vasu Tiwari
Typing :	Smt. C. Arora Sh. Satish Changra Sh. Ganga Singh Shahi Sh. Ravi Charan Smt. S. Menon

## **FOREWORD**

Under the Air (Prevention and Control of Pollution) Act, 1981, the Central Pollution Control Board (CPCB) initiated National Ambient Air Quality Monitoring programme in the year 1984 and the network of monitoring stations has been extended throughout the country. This report outlines the guidelines for carrying out ambient air quality monitoring including selection of monitoring stations, number and distribution of monitoring stations, selection of pollutants, measurement methods, sampling duration and frequency etc. The guidelines have been prepared on the basis of experience gained over the years in ambient air quality monitoring.

The report also describes quality assurance and quality control requirements in ambient air quality monitoring. The Ring Test facility developed in CPCB is explained in the report.

We hope, the guidelines will be useful to all concerned with air quality monitoring and management.

(Dilip Biswas)

# CONTENTS

Section No.	Title	Page No.
<b>1.0</b>	<b>Introduction</b>	<b>1</b>
1.1	Air (Prevention and Control of Pollution) Act 1981	2
1.2	National Ambient Air Quality Standards	2
<b>2.0</b>	<b>Air Pollution Problem in India</b>	<b>4</b>
2.1	Reasons for High Air Pollution in India	5
2.1.1	Vehicular Pollution Problems in India	6
2.2	Behaviour of Air Pollutants	7
2.2.1	Short-term Variations	7
2.2.2	Seasonal Variations	9
2.2.3	Long- term Variations	11
<b>3.0</b>	<b>Air Quality Monitoring</b>	<b>12</b>
3.1	Objectives of Air Quality Monitoring	12
3.2	National Air Quality Monitoring Programme (N.A.M.P.)	13
3.2.1	Objectives	13
3.2.2	Monitoring Locations and Parameters	13
<b>4.0</b>	<b>Guidelines for Monitoring</b>	<b>17</b>
4.1	Background Information	17
4.2	Components of Monitoring	18
4.2.1	Number and Distribution of Monitoring Locations	18
4.2.2	Selection of Monitoring Location	20
4.2.3	Selection of Pollutants	24
4.2.4	Sampling Duration and Frequency	26
4.2.5	Measurement Methods	26
4.2.6	Meteorological Measurements	27
4.2.7	Laboratory Requirements	28
4.2.8	Quality Assurance	28
4.2.9	Data Handling and Presentation	28
4.2.10	Financial Requirements	29
4.2.11	Manpower Requirements	30
4.2.12	Operation of Air Quality Monitoring Equipments	30
<b>5.0</b>	<b>Quality Assurance and Quality Control in Air Quality Monitoring</b>	<b>33</b>
5.1	Analytical Quality Control	33
5.1.1	Ring Test Facility at CPCB	41
5.2	Reasons for Poor Quality of Data	44
5.3	Suggestions for Improvement	45
	Annexure – I National Ambient Air Quality Standards	48
	Annexure – II Measurement Methods of Air Pollutants	49
	Annexure – III Format for Reporting Data	156
	References	161

## LIST OF TABLES

<b>Table No.</b>	<b>Title</b>	<b>Page No.</b>
2.1	Contribution of Air Pollution from Various Sources in Delhi (Source: MoEF, 1997)	4
2.2	Problem Areas in India	4
2.3	Percentage Violation of NAAQS (24-hourly Avg.) at Various Locations in Delhi.	8
4.1	Recommended Minimum Number of Stations , Population Wise ( Source: IS : 5182 (Part 14) , 2000)	19
4.2	Distribution of Sampling Stations (Source : WHO, 1977)	20
4.3	Recommended Criteria for Siting Monitoring Stations ( Source: IS 5182 (Part 14), 2000)	22
4.4	A Minimum Distance of the Sampler from Road for Measurement of Ozone and NOx (Source: ETC, Canada, 1995)	24
4.5	Operation and Maintenance cost of Monitoring Stations.	29
4.6	Capital Cost of Establishing Stations.	30

## LIST OF FIGURES

<b>Figure No.</b>	<b>Title</b>	<b>Page No.</b>
2.1	Correlation Between CO Levels and Percentage Calm Conditions in Delhi.	9
2.2	Monthly Average Concentrations ( 1995 – 2001) of SPM at BSZ Marg, New Delhi.	10
2.3	Monthly Average Concentrations of RSPM ( 1995 – 2001) at BSZ Marg, New Delhi.	11
2.4	Trend in Annual Average Concentration of Respirable Suspended Particulate Matter in Delhi.	11
3.1	Growth of Ambient Air Quality Monitoring Stations under NAMP.	14
3.2	State-wise Distribution of Ambient Air Quality Monitoring Stations under NAMP.	15
5.1	Flow Chart for Approach to Achieving Accuracy of Analytical Results.	34
5.2	Ring Test Facility	38
5.3	Static Volumetric Dilution	39

## LIST OF ANNEXURES

<b>Annexure No.</b>	<b>Title</b>	<b>Page No.</b>
I	National Ambient Air Quality Standards	48
II	Measurement Methods of Air Pollutants	49
1.	Air Sampling – Gaseous	49
2.	Measurement of Meteorological Parameters	56
3.	Determination of Suspended Particulate Matter in the Atmosphere (High Volume Method)	67
4.	Measurement of Respirable Suspended Particulate Matter (PM <sub>10</sub> ) in Ambient Air (Cyclonic Flow Technique)	78
5.	Determination of Sulphur Dioxide in Air (Modified West and Gaeke Method)	85
6.	Continuous Measurement of Sulphur Dioxide – Ultraviolet Fluorescence Method	96
7.	Continuous Measurement of Carbon Monoxide – Non-Dispersive Infrared Spectrometry Method	105
8.	Determination of Nitrogen Dioxide in the Atmosphere	119
9.	Continuous Measurement of Oxides of Nitrogen in Ambient Air by Chemiluminescence	128
10.	Determination of Ozone in the Atmosphere	140
11.	Continuous Measurement of Ozone in the Atmosphere by Ultraviolet Photometric Instruments	146
III	Format for Reporting Data	156



## 1.0 INTRODUCTION

Air pollutants are added in the atmosphere from variety of sources that change the composition of atmosphere and affect the biotic environment. The concentration of air pollutants depend not only on the quantities that are emitted from air pollution sources but also on the ability of the atmosphere to either absorb or disperse these emissions. The air pollution concentration vary spatially and temporarily causing the air pollution pattern to change with different locations and time due to changes in meteorological and topographical condition. The sources of air pollutants include vehicles, industries, domestic sources and natural sources. Because of the presence of high amount of air pollutants in the ambient air, the health of the population and property is getting adversely affected. In order to arrest the deterioration in air quality, Govt. of India has enacted Air (Prevention and Control of Pollution) Act in 1981. The responsibility has been further emphasized under Environment (Protection) Act, 1986. It is necessary to assess the present and anticipated air pollution through continuous air quality survey/monitoring programs. Therefore, Central Pollution Control Board had started National Ambient Air Quality Monitoring (NAAQM) Network during 1984 - 85 at national level. The programme was later renamed as National Air Quality Monitoring Programme (NAMP).

The report presents guidelines for carrying out ambient air quality monitoring under NAMP. Ambient air quality monitoring is carried out so as to generate data that meets the objectives of monitoring. Ambient air quality monitoring programme are needed to determine the existing quality of air, evaluation of the effectiveness of control programme and to develop new programme. The report aims towards developing a more uniform air monitoring network so that data from various stations is comparable. The report discusses the various aspects of air quality monitoring network such as, which pollutants should be monitored, location where monitoring should be carried out and the various techniques of monitoring. The legal requirements in India for carrying out ambient air quality monitoring are also discussed. These requirements serve as basis on which objectives of ambient air quality monitoring are determined.

The ambient air quality monitoring network involves measurement of a number of air pollutants at number of locations in the country so as to meet objectives of the monitoring. Any air quality monitoring network thus involves selection of pollutants, selection of locations, frequency, duration of sampling, sampling techniques, infrastructural facilities, man power and operation and maintenance costs. The network design also depends upon the type of pollutants in the atmosphere through various common sources, called common urban air pollutants, such as Suspended Particulate Matter (SPM), Respirable Suspended Particulate Matter (RSPM), Sulphur dioxide (SO<sub>2</sub>), Oxides of Nitrogen (NO<sub>x</sub>), and Carbon Monoxide (CO) etc. . The areas to be chosen primarily are such areas which represent high traffic density, industrial growth, human population and its distribution, emission source, public complaints if any and the land use pattern etc. Generally, most of the time the basis of a network design are the pollution source and the pollutant present.

## **1.1 Air (Prevention and Control of Pollution) Act 1981**

Government of India enacted the Air (Prevention and Control of Pollution) Act 1981 to arrest the deterioration in the air quality. The act prescribes various functions for the Central Pollution Control Board (CPCB) at the apex level and State Pollution Control Boards at the state level. The main functions of the Central Pollution Control Board are as follows:

- To advise the Central Government on any matter concerning the improvement of the quality of the air and the prevention, control and abatement of air pollution.
- To plan and cause to be executed a nation-wide programme for the prevention, control and abatement of air pollution.
- To provide technical assistance and guidance to the State Pollution Control Board.
- To carry out and sponsor investigations and research related to prevention, control and abatement of air pollution.
- To collect, compile and publish technical and statistical data related to air pollution; and
- To lay down standards for the quality of air and emission quantities.

The main functions of the State Pollution Control Boards are as follows:

- To plan a comprehensive programme for prevention, control and abatement of air pollution and to secure the execution thereof;
- To advise the State Government on any matter concerning prevention, control and abatement of air pollution.
- To collect and disseminate information related to air pollution.
- To collaborate with Central Pollution Control Board in programme related to prevention, control and abatement of air pollution; and
- To inspect air pollution control areas, assess quality of air and to take steps for prevention, control and abatement of air pollution in such areas.

## **1.2 National Ambient Air Quality Standards (NAAQS)**

The ambient air quality objectives/standards are pre-requisite for developing programme for effective management of ambient air quality and to reduce the damaging effects of air pollution. The objectives of air quality standards are: -

- To indicate the levels of air quality necessary with an adequate margin of safety to protect the public health, vegetation and property.
- To assist in establishing priorities for abatement and control of pollutant level;
- To provide uniform yardstick for assessing air quality at national level; and
- To indicate the need and extent of monitoring programme.

The Central Pollution Control Board had adopted first ambient air quality standards on November 11, 1982 as per section 16 (2) (h) of the Air (Prevention and Control of Pollution) Act, 1981. The air quality standards have been revised by the Central Pollution Control Board on April 11, 1994 and were notified in Gazette of India, Extraordinary Part-II Section 3, sub section (ii), dated May 20, 1994. The revised National Ambient Air Quality Standards are depicted in Annexure-I (Table A1.1). These standards are based on the land use and other factors of the area. The guidelines for declaring sensitive areas as recommended by peer/core group of CPCB are as follows:

**Sensitive areas** – sensitive area may include the following:

- 1) 10 kms all around the periphery of health resorts so notified by State Pollution Control Boards in consultation with department of public health of the concerned state.
- 2) 10 kms all around the periphery of biosphere reserves, sanctities and national parks, so notified by Ministry of Environment and Forest or concerned states.
- 3) 5 kms all around the periphery of an archeological monument declared to be of national importance or otherwise so notified by Archeological Survey of India (A.S.I.) in consultation with State Pollution Control Boards.
- 4) Areas where some delicate or sensitive to air pollution crops/important to the agriculture/horticulture of that area are grown so notified by State Pollution Control Boards in consultation with department of agriculture/horticulture of concerned state.
- 5) 5 kms around the periphery of centers of tourism and/or pilgrim due to their religious, historical, scenic or other attractions, so notified by department of tourism of the concerned state with State Pollution Control Boards.

## 2.0 AIR POLLUTION PROBLEM IN INDIA

Air pollution in India is mainly caused from three sources namely vehicles, industrial and domestic sources. The air pollution is mainly concentrated in following three areas

(i) **Major Cities:** The problem of air pollution is in major cities where the prominent source of air pollution is vehicles and small/medium scale industries. These cities include Delhi, Kolkata, Mumbai, Chennai, Ahmedabad, Bangalore, Hyderabad, Pune, Kanpur etc. A study carried out in Delhi shows the contribution of industrial (including thermal power plants), vehicular and domestic sources of pollution to the ambient air in Delhi as follows (Table 2.1, Source: MoEF, 1997).

**Table 2.1 Contribution of air pollution from various sources in Delhi (Source MoEF, 1997)**

Source	1970-71	1980-81	1990-91	2000-01 (Projected)
Industrial	56%	40%	29%	20%
Vehicular	23%	42%	64%	72%
Domestic	21%	18%	7%	8%

(ii) **Critically Polluted Areas:** 24 critically polluted areas have been identified in India where the problem of pollution exists. These areas are as follows:

**Table 2.2 : Problem Areas in India**

S.No.	Problem Area	Type of Industry
1	Singrauli	Power Plants, Mining, Aluminium Industry.
2	Korba	Power Plants, Aluminium Industry, Mining.
3	Vapi	Chemical Industries.
4	Ankaleshwar	Chemical Industries.
5	Greater Cochin	Oil Refineries, Chemical, Metallurgical Industries
6	Visakhapatnam	Oil Refinery, Chemical, Steel Plants.
7	Howrah	Foundry, Rerolling Mills
8	Durgapur	Chemical Industries, Power Plants, Steel Plants .
9	Manali	Oil Refineries, Chemical Industry, Fertilizer Industry
10	Chembur	Refineries, Power Plant, Fertilizer Industry.
11	Mandi Gobindgarh	Secondary Steel Industry
12	Dhanbad	Mining, Coke Oven
13	Pali	Cotton Textile, Dyeing

<b>S.No.</b>	<b>Problem Area</b>	<b>Type of Industry</b>
14	Nagafgarh Drain Basin	Power Plants, Vehicles
15	Angul-Talcher	Mining, Aluminium Plants, Thermal Power Plants.
16	Bhadravati	Iron & Steel, Paper Industry
17	Digboi	Oil Refinery
18	Jodhpur	Cotton Textile, Dye
19	Kala-Amb	Paper, Electroplating
20	Nagda-Ratlam	Viscose Rayon, Caustic, Dyes, Distillery
21	North Arcot	Tanneries
22	Parwanoo	Food Processing Unit, Electroplating
23	Patancheru - Bollaram	Organic Chemical, Paints Petrochemical Industry
24	Tarapur	Chemical Industry

**(iii) Rural Areas:** The indoor air pollution exists in rural areas where the main source of air pollution is domestic fuel used. In rural areas cow dung, woodsticks are used as fuel in household. The kitchen are without any proper ventilation resulting in buildup of air pollutants in the houses.

## **2.1 Reasons for High Air Pollution in India**

The reasons for high air pollution in India are as follows:

### **(i) Poor Quality of Fuel**

Fuel of poor quality such as coal, diesel, petrol, fuel oil is used in India. Although during the past few years, various measures have been taken to improve the quality of fuel such as reduction of sulphur in diesel, unleaded petrol etc.

### **(ii) Old Process Technology**

Old process technology is employed in many industries especially in small scale industries resulting in high emission of air pollutants

### **(iii) Wrong Siting of Industries**

Wrong siting of industries especially close to residential areas results in people getting affected due to air pollution.

### **(iv) No Pollution Preventive Step in Early Stage of Industrialization**

No pollution preventive steps were taken in early stage of industrialization which has resulted in high levels of air pollutants in many areas.

#### **(v) Poor Vehicle Design**

Poor vehicle design especially 2-stroke two wheelers result in high emission of air pollutants.

#### **(vi) Uncontrolled Growth of Vehicle Population**

Uncontrolled growth of vehicle population in all major cities/towns has resulted in high levels of air pollution.

#### **(vii) No Pollution Prevention and Control System in Small/ Medium Scale Industry**

No pollution prevention and control system in small/medium scale industry exists resulting in high levels of air pollution.

#### **(viii) Poor Compliance of Standard in Small/Medium Scale Industries**

Poor compliance of standard in small/medium scale industries also result in high levels of air pollution.

### **2.1.1 Vehicular Pollution Problems In India**

Vehicles are one of the major sources of air pollution in major cities. The air pollution due to vehicles can be attributed to following:

(i) High vehicle density in Indian urban centers result in air pollution buildup near the roadways and at traffic intersections.

(ii) Older vehicles are predominant in vehicle vintage. These older vehicles are grossly polluting though in cities like Delhi grossly polluting vehicles have been phased out.

(iii) Inadequate inspection and maintenance facilities result in high emission of air pollutants from vehicles. Emission can be reduced by proper and regular inspection and maintenance of vehicles.

(iv) There are large number of two stroke two wheelers in most of the cities and these two-wheelers are a significant contributor of air pollution.

(v) Adulteration of fuel and fuel products also result in high emissions from vehicles.

(vi) Improper traffic management system and road conditions also result in buildup of air pollutants near the roadways as the emissions are higher when the vehicle is idling.

(vii) Absence of effective mass rapid transport system and intra-city railway networks have resulted in people using their own vehicles for commuting to workplace. This has resulted in uncontrolled growth of vehicles.

(viii) High population exodus to the urban centers has also resulted in increase in number of vehicles resulting in high levels of vehicular air pollution.

Major manmade sources of Respirable Suspended Particulate Matter (RSPM) and Fine Particulate Matter (FPM) are as follows:

- (i) Emission from coal based power station
- (ii) Emission from oil fired furnace/boiler
- (iii) Emission from stone crusher, hot mix plants, lime kilns, foundry
- (iv) Hospital waste incinerator
- (v) Emission from stationery DG sets/portable DG sets
- (vi) Emission from diesel vehicles ( bus and trucks)
- (vii) Emission from 2- stroke vehicles (2T oil used)
- (viii) Resuspension of road dust
- (ix) Burning of biomass/tyre, tube
- (x) Emission from waste oil reprocessing industries.

## **2.2 Behaviour of Air Pollutants**

Air pollutants show short term, seasonal and long term variations. Atmospheric conditions determine the fate of the air pollutants after their release into the atmosphere. The mean transport wind velocity, turbulence and mass diffusion are three important and dominant mechanisms in the air pollutant dispersal. Meteorology plays a major role in study of air pollution. The wind speed and direction play a major role in dispersion of air pollutants. The wind direction is the measurement of direction from which the wind is blowing, measured in points of compass viz. North, South, East, West or in Azimuth degrees. Wind direction has an important role in distributing and dispersing pollutants from stationary and mobile sources in horizontally long downwind areas. The wind speed is the measure of horizontal motion of wind relative to the surface of earth per unit time. The effect of wind speed on air pollution is two-fold. It determines the travel time from a source to a given receptor while on the other causes dilution of pollutants in downwind direction. The stronger the wind, the greater will be the dissipation and dilution of pollutants emitted. A knowledge of the frequency distribution of wind direction as well as wind speed is essential for accurate estimation of the dispersion of pollutants in the atmosphere. The frequency distribution of wind speed and direction varies considerably from month to month.

### **2.2.1 Short – term Variations**

Air pollutants show diurnal variations in their levels. During the daytime, solar heating causes maximum turbulence and strongest vertical motions. This causes the maximum amount of momentum exchange between the various levels in the atmosphere. On clear nights with light winds, heat is radiated from the Earth's surface resulting in cooling

of the ground and air adjacent to it. This results in extreme stability of the atmosphere near the Earth's surface. Under these conditions turbulence is at a minimum.

Violation of NAAQS (24-hourly avg.) of sulphur dioxide (SO<sub>2</sub>), nitrogen dioxide (NO<sub>2</sub>), SPM is given in Table 2.3. There was no violation of NAAQS (24-hourly avg.) with respect to SO<sub>2</sub> and NO<sub>2</sub> at locations in residential and industrial areas in Delhi from 1995 to 2001. At traffic intersection, there was no violation of NAAQS (24 hourly avg.) with respect to SO<sub>2</sub> from 1998 to 2001. There was violation of NAAQS (24-hourly Avg.) with respect to NO<sub>2</sub> and SPM at traffic intersection area from 1995 to 2001. There was violation of NAAQS (24-hourly avg.) with respect to SPM at locations in residential area from 1995 to 2001. At location in industrial areas there was violation of NAAQS (24 hourly avg.) with respect to SPM during many years.

**Table 2.3: Percentage Violation of NAAQS (24-hourly average) at various locations in Delhi.**

Parameter / Year	Location	1995	1996	1997	1998	1999	2000	2001	
SO <sub>2</sub>	R	Nizamuddin	0	0	0	0	0	0	0
		Ashok Vihar	0	0	0	0	0	0	0
		Janak Puri	0	0	0	0	0	0	0
		Siri Fort	0	0	0	0	0	0	0
	I	Shahdara	0	0	0	0	0	0	0
		Shahzada Bagh	0	0	0	0	0	0	0
	T.I.	BSZ Marg	7	2.4	0.4	0	0	0	0
NO <sub>2</sub>	R	Nizamuddin	0	0	0	0	0	0	0
		Ashok Vihar	0	0	0	0	0	0	0
		Janak Puri	0	0	0	0	0	0	0
		Siri Fort	0	0	0	0	0	0	0
	I	Shahdara	0	0	0	0	0	0	0
		Shahzada Bagh	0	0	0	0	0	0	0
	T.I.	BSZ Marg	21	36	22	21	15	14	18
SPM	R	Nizamuddin	98	49	95	52	89	87	67
		Ashok Vihar	99	32	87	60	100	86	72
		Janak Puri	100	38	88	97	100	92	78
		Siri Fort	97	27	96	99	99	86	90
	I	Shahdara	33	53	5	3	7	17	6
		Shahzada Bagh	7	37	1	14	13	42	21
	T.I.	BSZ Marg	95	97	98	96	96	97	95



## 2.2.2 Seasonal Variation

### a) Seasonal Variation in Carbon Monoxide (CO) Concentrations

Monthly average of CO measured at Bahadur Shah Zafar (BSZ) Marg is plotted alongwith percentage calm conditions during 1999 in Figure 2.1. More are the calm conditions during winter higher are levels of CO. The concentrations are maximum in winter months and are low during summer and monsoon months. A plausible explanation for these results may be found by examining meteorological conditions. The general meteorology during the winter is dominated by high pressure causing increased atmospheric stability, which in turn allows for less general circulation and thus more stagnant air masses. Stagnant air masses allow more accumulation of pollutants in any given area.

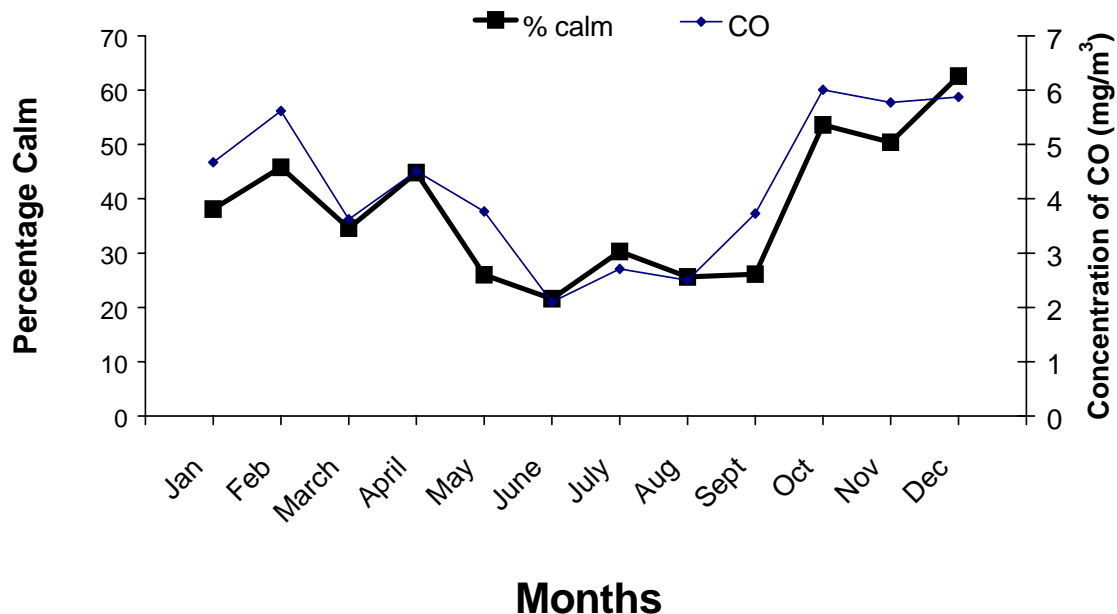

**Figure 2.1: Correlation between CO levels and Percentage Calm conditions in Delhi.**

During the winter, average mixing height is lower as compared to other seasons and atmospheric dispersion is typically at a minimum and therefore the pollutants will not be as widely dispersed. During the summer months, the average mixing height is typically at its greatest resulting in increased mixing through a greater volume of the troposphere, and hence lower pollutant concentrations. The monsoons results in large amount of precipitation, high wind velocities and changes in general wind direction. The large amounts of precipitation reduce atmospheric pollution via associated wet

deposition processes. Further wind velocities will allow for pollutant transport away from sources, increase mixing processes and the winds coming from the marine environment will have less background concentrations than that of continental air masses.

### **b) Seasonal Variation in Suspended Particulate Matter (SPM) & Respirable Suspended Particulate Matter (RSPM) Concentrations**

The monthly average concentration of SPM (1995-2001) and RSPM (1999-2001) measured at BSZ Marg is shown in Figure 2.2 and 2.3 respectively. The strong and medium winds during April to June creates turbulent conditions and local disturbances in the environment which cause frequent dust storm and hazy conditions. These dust storms and hazy conditions build up high particulate matter levels in the ambient air, mostly constituting soil borne particles.

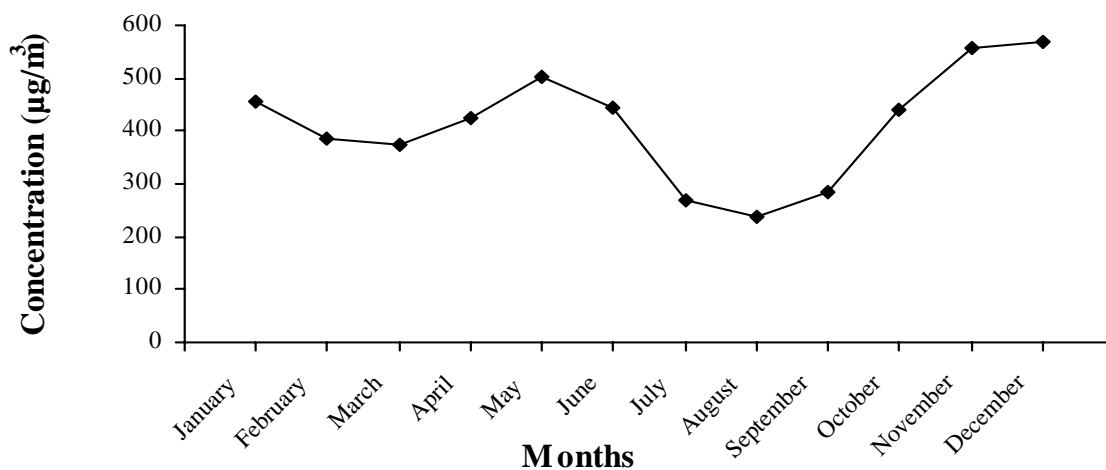

**Figure 2.2: Monthly Average Concentrations (1995-2001) of SPM at BSZ Marg, New Delhi.**

During monsoon, mostly winds from east prevail. Most frequent rains washes down the air borne particulates and other pollutants generated and dispersed from the sources in the environment, therefore the period from July to September is cleaner period in the year. The winter months are relatively much calm than other months. The prevailing calm conditions facilitate more stability to atmosphere and consequently slow dispersion of pollutants generated and help in build up of pollutants in vicinity of the pollutant sources. Lower average mixing height in winter season results in less volume of troposphere available for mixing and hence higher SPM and RSPM concentrations.

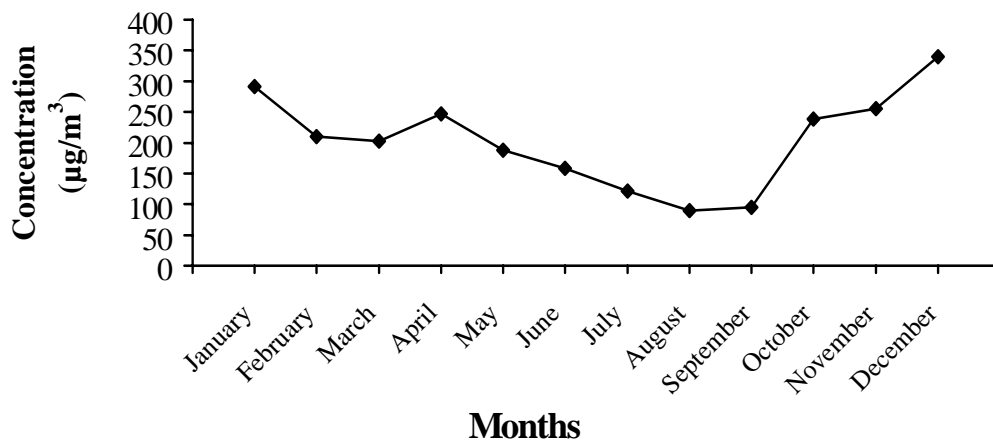

**Months**  
**Figure 2.3: Monthly Average Concentrations of RSPM (1999-2001) at BSZ Marg, New Delhi.**

### 2.2.3 Long Term Variations

Status and Trend in annual average concentration of respirable suspended particulate matter (RSPM) in residential areas, industrial areas and traffic intersection area is shown in Fig.2.4. RSPM levels measured at traffic intersection have decreased during 2001 as compared to previous years. RSPM levels at locations in residential areas and traffic intersection were higher than the NAAQS (annual average) during 2001.

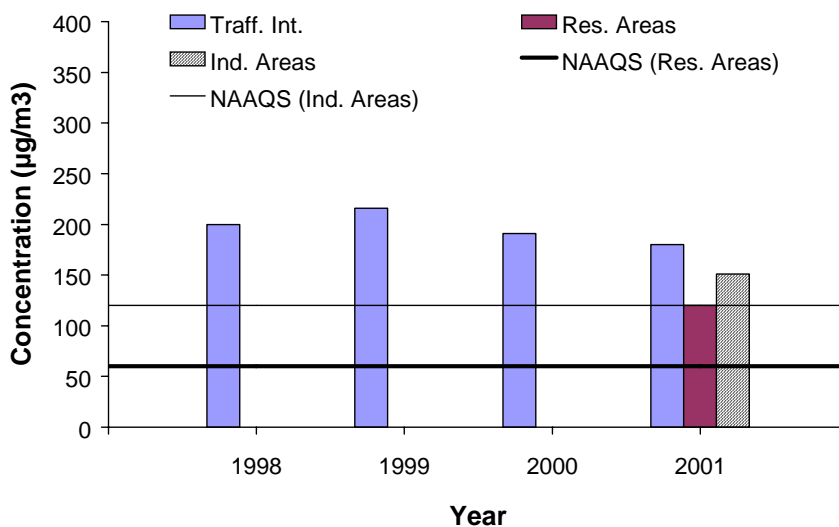

**Fig. 2.4: Trend in Annual Average Concentration of Respirable Suspended Particulate Matter in Delhi.**

## **3.0 AIR QUALITY MONITORING**

Ambient air quality monitoring is required to determine the existing quality of air, evaluation of the effectiveness of control programme and to identify areas in need of restoration and their prioritization. National Air Quality Monitoring Programme is described in this chapter alongwith details on pollutants measured and their frequency. Guidelines for monitoring are made for carrying out ambient air quality monitoring under NAMP and description of the programme is essential as the monitoring is carried out to meet the objectives of NAMP.

### **3.1 Objectives of Air Quality Monitoring**

The major objectives for air quality monitoring are as below:

#### **(i) Background Data**

In order to generate background data, air quality monitoring is conducted to assess existing level of contamination and to assess possible effects of air contamination occurring in future.

#### **(ii) Status and Trend Evaluation**

The objective is to determine air pollution status and trend information from any continuous air quality monitoring programme. The information is used to determine, whether pollution control strategies as advised by implementing authority are giving acceptable values that is lowering of pollution levels or new or additional control are required to achieve acceptable levels.

#### **(iii) Environment Exposure Level Determination**

The air quality monitoring and survey concern itself with systematic study of considerable segment of environment to define inter-relationship of source of pollution, atmospheric parameter and measurable manifestations in order to evaluate the character and magnitude of existing problem.

#### **(iv) Scavenging Behaviour of Environment**

To understand natural scavenging or cleansing process undergoing in the environment through pollution dilution, dispersion, wind movement, dry deposition, precipitation and chemical transformation of pollutants generated.

#### **(v) Air Quality Management**

To assess the present status to judge effectiveness of air pollution control strategies and long term management of air quality.

## **3.2 National Air Monitoring Programme (N.A.M.P.)**

Central Pollution Control Board initiated National Ambient Air Quality Monitoring (NAAQM) programme in the year 1984 with 7 stations at Agra and Anpara. Subsequently the programme was renamed as National Air Monitoring Programme (N.A.M.P.). The number of monitoring stations under N.A.M.P. has increased, steadily, to 295 by 2000-01 covering 98 cities/towns in 29 States and 3 Union Territories of the country.

### **3.2.1 Objectives**

The objectives of the N.A.M.P. are as follows:

- To continue ongoing process of producing periodic evaluation of air pollution situation in urban areas of the country.
- To determine status and trend in ambient air quality and effects of air pollution in urban environment
- To estimate the future worsening or improvement of air quality and to obtain the knowledge and understanding necessary for developing preventive and corrective measures.
- To understand the natural cleansing process undergoing in the environment through pollution dilution, dispersion, wind based movement, dry deposition, precipitation and chemical transformation of pollutants generated.
- To ascertain whether the prescribed ambient air quality standards are violated and to assess health hazard, damage to materials and to control and regulate pollution from various sources.

### **3.2.2 Monitoring Locations and Parameters**

Under N.A.M.P., four air pollutants *viz.*, Sulphur Dioxide (SO<sub>2</sub>), Oxides of Nitrogen as NO<sub>2</sub> and Suspended Particulate Matter (SPM) and Respirable Suspended Particulate Matter (RSPM/PM<sub>10</sub>), have been identified for regular monitoring at all the locations. Besides this, additional parameters such as Respirable Lead and other toxic trace metals, Hydrogen Sulphide (H<sub>2</sub>S), Ammonia (NH<sub>3</sub>) and Polycyclic Aromatic Hydrocarbons (PAHs) are also being monitored in 10 metro-cities of the country, since 1990. The monitoring of meteorological parameters such as wind speed and direction, relative humidity and temperature was also integrated with the monitoring of air quality. The growth of monitoring network is shown in Figure 3.1.

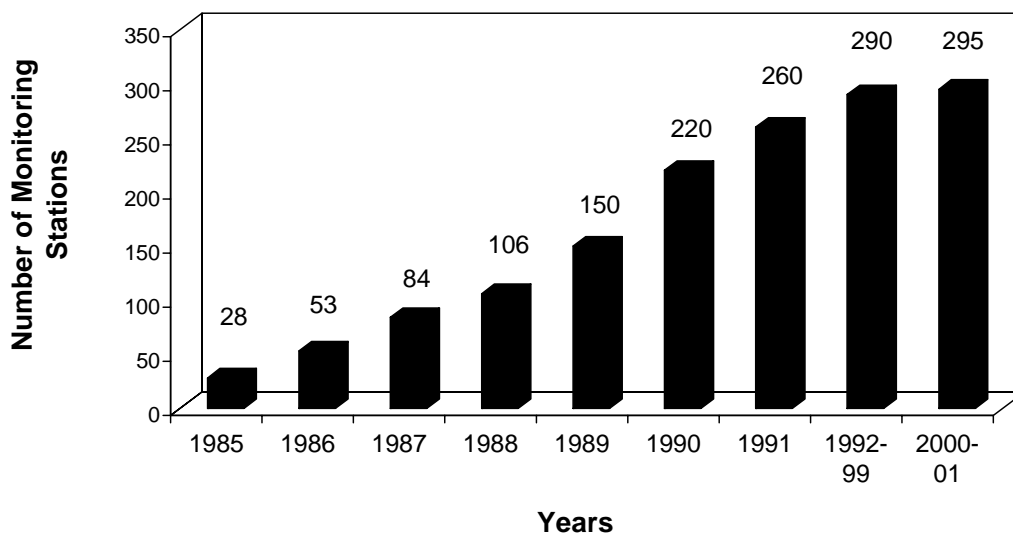
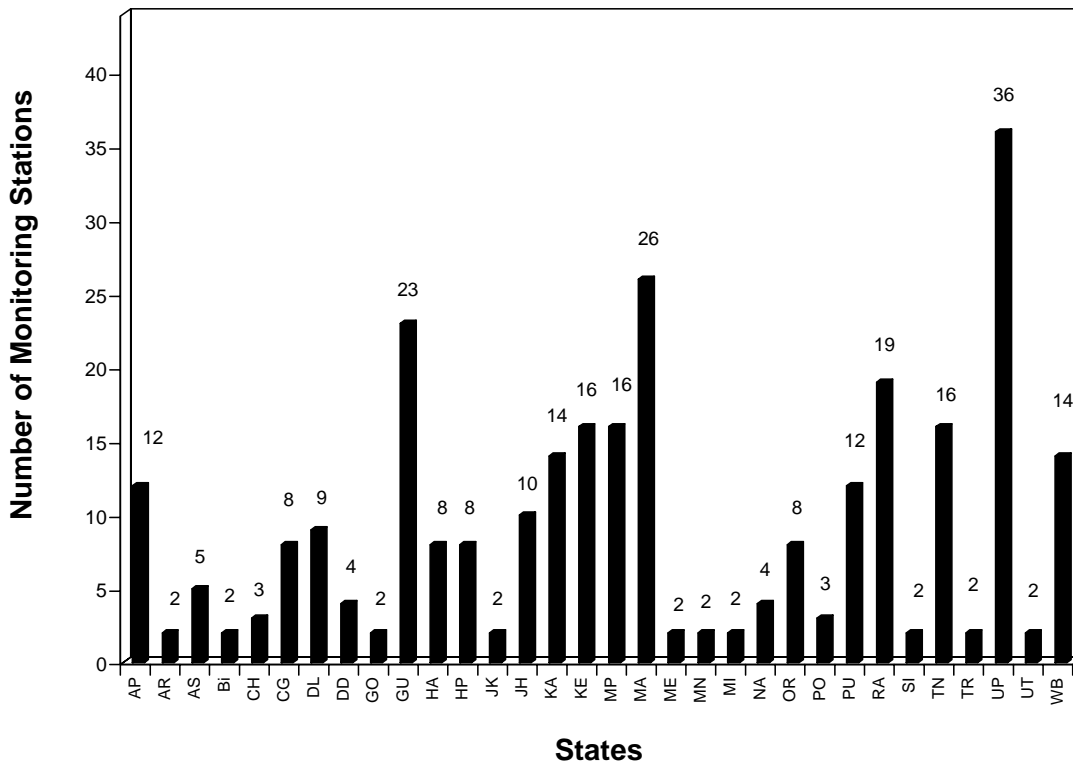

**Figure 3.1: Growth of Ambient Air Quality Monitoring stations under N.A.M.P.**

The monitoring of pollutants is carried out for 24 hours (4-hourly sampling for gaseous pollutants and 8-hourly sampling for particulate matter) with a frequency of twice a week, to have 104 observations in a year.

N.A.M.P., being a nationwide network, involves several agencies which are:

- Central Pollution Control Board: in Delhi;
- State Pollution Control Boards : in the respective States;
- Pollution Control Committees: in the respective Union Territories;
- National Environmental Engineering Research Institute (NEERI), Nagpur: in 10 metro cities of the country;
- Visvesvaraya Regional College of Engineering, Nagpur: in the city of Nagpur;
- University of Pune, Pune: in the city of Pune;
- KTHM College, Nasik: in the city of Nasik ;
- Walchand Institute of Technology, Solapur: in the city of Solapur; and
- Thane Municipal Corporation in the city of Thane



**Figure 3.2: State-wise Distribution of Ambient Air Quality Monitoring Stations under N.A.M.P.**

AP – Andhra Pradesh	AR – Arunachal Pradesh	AS – Assam	Bi – Bihar
CH – Chandigarh	CG – Chattisgarh	DL – Delhi	DD – Daman, Diu NH
GO _Goa	GU – Gujarat	HA– Haryana	HP - Himachal Pradesh
JK - Jammu & kashmir	JH – Jharkand	KA – Karnataka	KE – Kerala
MP - Madhya Pradesh	MA – Maharashtra	ME – Meghalaya	MN – Manipur
MI – Mizoram	NA – Nagaland	OR – Orissa	PO – Pondicherry
PU – Punjab	RA –Rajasthan	SI - Sikkim	TN – Tamil Nadu
TR – Tripura	UP – Uttar Pradesh	UT – Uttaranchal	WB – West Bengal

CPCB co-ordinates with these agencies to ensure the uniformity, consistency of air quality data and provides technical and financial support to them for operating the monitoring stations. State-wise distribution of monitoring stations is shown in Figure 3.2. Since the target sampling of 24 hours in a day could not be fulfilled at all the locations due to power failures etc., the values monitored for 16 hours and more are considered as representative values for assessing the ambient air quality for a day. The target frequency of monitoring twice a week, 104 days in a year could not be met in some of the locations, in such cases 40 and more days of monitoring in a year is considered adequate for the

purpose of data analysis. The outliers from the data were removed. N.A.M.P. is being operated through various monitoring agencies, large number of personnel and equipment are involved in the sampling, chemical analyses, data reporting etc. It increases the probability of variation and personnel biases reflecting in the data, hence it is pertinent to mention that these data be treated as indicative rather than absolute.



## **4.0 GUIDELINES FOR MONITORING**

For setting up of any ambient air quality monitoring station, the most important thing to be considered prior to commencement of actual monitoring is to collect its background information.

### **4.1 Background Information**

The background information that needs to be collected includes details of sources and emissions, health status, demography, population growth, landuse pattern, epidemiological studies. Such prior information will provide immense help to identify the likely effects and in particular health impacts resulting from population exposure to air pollutants.

#### **(i) Sources and Emissions**

Sources in a city includes vehicles, industries, domestic etc. In an industrial area, information should be obtained on the type of industries including their number, fuel used, composition of fuel, pollutants emitted etc. Information on number and distribution of sources should be collected. This information will help in identifying which pollutants can be expected in an area and thus should be measured. In case of industrial stacks, locations of maximum ground level concentrations should be determined by modeling. The stations should be located at locations where maximum ground level concentrations are expected. Information on type and number of vehicles should be obtained. Information on domestic fuel that is used in household should be obtained. Pollution load emanating from these sources should be estimated so as to identify sources that are generating significant amount of pollution.

#### **(ii) Health and Demographic Information**

Investigations shall be carried out based on the public complaints received from an area related to air pollution. If the results of such investigations reveal that the level are high that area can be considered for ambient air quality monitoring.

Areas where population density is high (more than one million) can be considered for locating monitoring stations. Information on age and socio-economic status of population is also important for making a decision on initiation of ambient air quality monitoring. Location of monitoring station in such areas will help in finding exposure levels to population which can be used further in epidemiological studies to evaluate health effects of air pollutants.

#### **(iii) Meteorological Information**

Meteorological data with respect to temperature, relative humidity, wind speed and direction should be collected. Predominant wind direction plays an important role in

determining location of monitoring stations. Due to effects such as land and sea breezes, valley effects etc. it is important to collect local meteorological data specific to the site. The monitoring stations should be located in areas that are downwind from the sources. Mixing height data should also be collected. Mixing height data can be collected from Indian Meteorological Department. Information on duration of various seasons in a year is also important. Measurement frequency should be such that monitoring is done in all the seasons so that all seasonal variations are included in computing annual average.

#### **(iv) Topographical Information**

Local winds and stability conditions are affected by topography. In river valleys there is increased tendency of developing inversions. More number of monitoring stations should be located in areas where spatial variations in concentrations is large. Mountains, hills, water bodies also affect dispersion of pollutants.

#### **(v) Previous Air Quality Information**

Any previous information collected on ambient air quality can serve as a basis for selecting areas where monitoring should be conducted and previous studies may include data collected for any health studies etc. Previous studies can be used to estimate the magnitude of the problem.

Once the background information is collected, the ambient air quality monitoring is to be initiated and selection of type of pollutant to be measured, number and distribution of monitoring stations etc. should be made.

### **4.2 Components of Monitoring**

The following parameters needs to be decided for carrying out ambient air quality monitoring.

#### **4.2.1 Number and Distribution of Monitoring Locations**

Knowledge of existing air pollutants levels and pattern within the area are essential for deciding number and distribution of stations. Isoleths distribution of an ambient concentrations determined from modeling or previous air quality information can be used to determine number and distribution of stations. When isopleths maps are not available information of emission densities and land use pattern may be used with windrose data to determine areas of expected higher concentrations. The number of monitoring stations in a city can be selected based on background information collected on sources and emissions, Population figures which can be used as indicators of region variability of the pollutants concentration

The no. of sampling sites depends on

- ◆ Size of the area to be covered

- ◆ The variability of pollutant concentration over the area to be covered
- ◆ The data requirements, which are related to the monitoring
- ◆ Pollutant to be monitored and
- ◆ Population figures which can be used as indicators of criticality both from view of likely air quality deterioration as also health implications.

A general guide to the no. of minimum stations and its distribution needed for monitoring trends of the common pollutants in urban areas based on population consideration is recommended in the Table. 4.2 as per IS 5182 Part 14; 2000. These criteria is for reference only, actual criteria followed at site must be based on compromise between available resources and site specific parameters such as size of the area to be covered, variability in pollutants concentration etc.

**Table 4.1 : Recommended Minimum Number of Stations, Population-wise  
(Source: IS : 5182 (Part 14), 2000).**

<b>Pollutant</b>	<b>Population of Evaluation Area</b>	<b>Minimum No. of AAQ Monitoring Station</b>
<b>SPM (Hi-Vol.)</b>	<100 000	4
	100 000- 1000 000	4+0.6 per 100 000 population
	1000 000 – 5000 000	7.5 + 0.25 per 100 000 population
	>5000 000	12 + 0.16 per 100 000 population
<b>SO<sub>2</sub> (Bubbler)</b>	<100 000	3
	100 000- 1 000 000	2.5+0.5 per 100 000 population
	1000 000 - 10 000 000	6+0.15 per 100 000 population
	>10 000 000	20
<b>NO<sub>2</sub> (Bubbler)</b>	<100 000	4
	100 000- 1000 000	4+0.6 per 100 000 population
	>1000 000	10
<b>CO</b>	<100 000	1
	100 000- 5 000 000	1+0.15 per 100 000 population
	>5 000 000	6+0.05 per 100 000 population
<b>Oxidants</b>	-do-	-do-

For other monitoring objectives, particularly in relation to epidemiological studies, the nos. will have to be increased. There are several other modifying factors as follows :

- ◆ In highly industrialized cities the no. of stations for SPM and SO<sub>2</sub> must be increased.

- ♦ In areas, where large amounts of heavy fuels are used the no. of stations for SO<sub>2</sub> should be more or vice-versa.
- ♦ In regions with irregular terrain, increase the no. of stations.
- ♦ In cities with extremely heavy traffic the no. of stations for NO<sub>x</sub> , Oxidants and CO may need to be doubled.
- ♦ In cities with low traffic and a population of > 4 million, the no. of station for SO<sub>2</sub> , NO<sub>x</sub> and CO can be reduced.

Table 4.1 (Source: WHO 1977) gives guide to the distribution of stations. These criteria is for reference only, actual criteria followed at site must be based on compromise between available resources and site specific parameters such as size of the city, nature of terrain and spatial variations in the concentrations of the pollutants etc. It is assumed in these tables that population figures are indicators of region size and pollution variability. The number of monitoring stations are generally based on experience gathered over the years in monitoring and can be increased or decreased based on the analysis of data obtained in monitoring. Resource availability is also an important factor in determining the number of monitoring stations in a city. Generally three monitoring stations are chosen as one each in residential (or commercial), sensitive and industrial area. Distribution of monitoring station in a city depend on the distribution of pollution sources and population in a city. More stations should be located in areas where population density is high, number of industries are more and vehicular density is high. Distribution of stations can also be carried out by dividing the entire area in a grid and locating stations at intersections of a grid or within a grid. However, the grid pattern is not very economical as most often it requires large number of stations in a city. Dispersion models can be used to find maximum pollution levels and spatial variation of pollutant concentration can be used to determine distribution of stations.

**Table: 4.2 Distribution of Sampling Stations (Source: WHO, 1977)**

Total number of stations	Number of stations	
	In city centre or industrial areas	In residential areas
1	1	0
2	1	1
3	2	1
4	2	2
5	3	2
10	6	4

#### 4.2.2 Selection of Monitoring Location

Principal factors governing the locations of the sampling stations are the objectives, the particular method of instrument used for sampling, resources available, physical access and security against loss and tampering. Air quality monitoring should be done in areas where pollution problem exists or is expected i.e. mainly in industrial areas, urban

areas, traffic intersections etc. One of the objective of monitoring is to determine status and trends and the air quality monitoring should be done in metropolitan cities and other urban areas so as to compare their levels and determine trends. Selection of site is very important as a incorrect location may result in data that may not meet the objectives of monitoring and will be of limited value. In general the following requirements should be satisfied for site selection.

### **(a) Representative Site**

A site is representative if the data generated from the site reflects the concentrations of various pollutants and their variations in the area. It is not easy to specify whether the location of the station is satisfactory or not, however it may be checked by making simultaneous measurements at some locations in the area concerned. The station should be located at a place where interferences are not present or anticipated. In general the following conditions should be met:

1. The site should be away from major pollution sources. The distance depends upon the source, its height and its emissions. The station should be at least 25 m away from domestic chimneys, especially if the chimneys are lower than the sampling point ; with larger sources the distance should be greater (WHO,1977).
2. The site should be away from absorbing surfaces such as absorbing building material. The clearance to be allowed will depend on the absorbing properties of the material for the pollutant in question, but it will normally be at least 1 m. (WHO, 1977).
3. The objective of monitoring is often to measure trends in air quality and measurements are to be conducted over a long time; thus the site should be selected such that it is expected to remain a representative site over a long time and no landuse changes, rebuildings etc. are foreseen in near future.

The instrument must be located in such a place where free flow of air is available. The instrument should not be located in a confined place, corner or a balcony.

### **(b) Comparability**

For data of different stations to be comparable, the details of each location should be standardised. The following is recommended in IS 5182 (Part 14) 2000

- (i) On all the sides it should be open, that is the intake should not be within a confined space, in a corner, under or above a balcony.
- (ii) For traffic pollution monitoring the sampling intake should be 3 m above the street level. The height of 3m is recommended to prevent re-entrainment of particulates from the street, to prevent free passage of pedestrians and to protect the sampling intake from vandalism.

- (iii) Sampling in the vicinity of unpaved roads and streets results in entrainment of dust into the samplers from the movement of vehicles. Samplers are therefore to be kept at a distance of 200 m from unpaved roads and streets.

**(c) Physical requirement of the monitoring site**

Following physical aspects of the site must be met

- The site should be available for a long period of time
- Easy access to the site should be there anytime throughout the year.
- Site sheltering and facilities such as electricity of sufficient rating, water , telephone connection etc. should be available.
- It should be vandal proof and protected from extreme weather

Highest concentrations and concentration gradients of carbon monoxide are likely to be in the vicinity of roads, highways. The gradients vary in both time and space on the micro and on the neighbourhood scale. The recommended criteria for siting monitoring stations for CO is given in Table 4.3 (IS 5182 (Part 14) : 2000). These criteria is for reference only, actual criteria followed at site must be based on compromise between available resources and site specific parameters such as nearby sources, concentration gradients of pollutants etc.

**Table 4.3: Recommended Criteria for Siting Monitoring Stations (Source: IS : 5182 (Part 14), 2000).**

Station Type	Description
Type A	<p><b>Downtown pedestrian exposure stations</b></p> <p>Locate station in the central urban area in a congested, downtown street surrounded by building where many pedestrian walk. Average daily travel on the street should exceed 10000 vehicles with average speed of less than 6.7 m/s. Monitoring probe is to be located 0.5 m from the curb at a height of <math>3 \pm 0.5</math> m</p>
Type B	<p><b>Downtown neighborhood exposure station</b></p> <p>Locate station in the central urban area but not close to any major street. Specifically streets with average daily travel exceeding 500 vehicles should be located at atleast 100 m away from the monitoring station. Typical locations are parks, malls or landscaped areas having no traffic. Probe height is to be <math>3 \pm 0.5</math> m above the ground.</p>

Station Type	Description
Type C	<p><b>Residential Station</b></p> <p>Locate station in the midst of a residential area or sub-urban area. Station should be more than 100 m away from any street having a traffic volume in excess of 500 vehicles/day. Station probe height must be <math>3 \pm 0.5</math> m.</p>
Type D	<p><b>Mesoscale Station</b></p> <p>Locate station in the urban area at appropriate height to collect meteorological and air quality data at upper elevations. The purpose of this station is not to monitor human exposure but to gather trend data and meteorological data at different height. Typical locations are tall buildings and broadcast towers. The height of the probe, along with the nature of the station location must be carefully documented in each case.</p>
Type E	<p><b>Non – urban station</b></p> <p>Locate station in a remote non- urban area having no traffic and no industrial activity. The purpose of this station is to monitor for trend analysis for non – degradation assessments and for large scale geographical surveys, the location or height must not be changed during the period over which trend is examined. The height of the probe must be documented in each case. A suitable height is <math>3 \pm 0.5</math> m.</p>
Type F	<p><b>Specialised source survey station</b></p> <p>Locate station very near a particular air pollution source scrutiny. The purpose of the station is to determine the impact on air quality, at specified locations, of a particular emission source of interest. Station probe height should be <math>3 \pm 0.5</math> m unless special considerations of the survey require non – uniform height.</p>

#### (d) Topographical and Meteorological Factors

Topographical and meteorological factors must also be considered for selecting a monitoring site. The topographical factors that must be considered are mountains, valleys, lakes, oceans and rivers. These factors cause a meteorological phenomena that may affects air pollutants distribution.

Winds caused by daytime heating and nighttime cooling may affect pollutant transport causing either buildup of pollutants or dilution. Canyons or valleys may channel the local winds into a particular direction resulting in increase in wind speed. The presence of

large water bodies may cause a land-sea breeze wind pattern which may determine pollutant transport. The mountain or hilly terrain may cause precipitation that may affect pollutant concentration. A minimum distance of the sampler from road for measurement of Ozone and NO<sub>x</sub> is given in Table 4.4 (Source: ETC. Canada). These criteria is for reference only, actual criteria followed at site must be based on compromise between available resources and site specific parameters such as nearby sources, concentration gradients of the pollutants, topographical features etc.

**Table 4.4: A minimum distance of the sampler from road for measurement of Ozone and NO<sub>x</sub> (Source: ETC, Canada, 1995).**

Average Traffic (vehicle per day)	≤ 10,000	15,000	20,000	40,000	70,000	≥ 110,000
Minimum distance of sampler from road (meters)	≥ 10	20	30	50	100	≥ 250

In general the following requirement may be met for siting the monitoring station.

- (i) Height of the inlet must be 3 – 10 m above the ground level.
- (ii) The sampler must be more than 20 m from trees.
- (iii) Distance of the sampler to any air flow obstacle i.e. buildings, must be more than two times the height of the obstacle above the sampler.
- (iv) There should be unrestricted airflow in three of four quadrants
- (v) There should be no nearby furnace or incinerator fumes.

Once a area has been selected for locating a monitoring stations, the site can be selected by finding maximum concentration using air quality modeling. Modeling refers to the mathematical expression for the fate of pollutants when they are released into the atmosphere taking into consideration the various aspects of atmospheric effects such as dispersion, advection etc. Air quality models are capable of predicting the temporal and spatial distribution of pollutants for a given domain of interest. Air quality modeling can be applied to ground level sources, elevated points sources, line sources, areas sources, flying sources under unlimited mixing, limited mixing, inversion, fumigation, trapping and also on complex terrain, flat terrain and coastal areas. The methodology is different in each case. Maximum ground level concentrations can be calculated where the air quality monitoring station can be located.

### 4.2.3 Selection of Pollutants

Prior to selection of pollutants, an emission inventory study or modeling results can be carried out or used if available. The pollutants expected from the sources present should be monitored. For monitoring in metropolitan cities and urban areas, the common urban air pollutants such as carbon monoxide, SO<sub>2</sub>, NO<sub>2</sub>, SPM and RSPM should be measured on a regular basis. Resource availability can play a very important role in determining the pollutants to be measured in an area. If enough resources are



available then monitoring of specific parameters such as Polycyclic Aromatic Hydrocarbons (PAHs), ozone etc. can also be carried out.

The pollutant selection criteria is as follows:

### **1. Criteria for SO<sub>2</sub> Measurements**

Sources of SO<sub>2</sub> include domestic emissions from fossil fuel burning, industrial emissions and diesel vehicles. The station should be located where populations are large and where pollution levels are high. Actual number of stations in any specific area depends on local factors such as meteorology, topography, resources available etc.

### **2. Criteria for NO<sub>2</sub> Measurements**

NO<sub>2</sub> is formed in the atmosphere by reaction of nitric oxide (NO) with ozone and hydrocarbons (HC). Thus high NO<sub>2</sub> levels are expected at locations where NO, ozone and hydrocarbons levels are high. Generally areas with high population and traffic are chosen for measuring NO<sub>2</sub>. Since ozone is formed downwind from the sources, NO<sub>2</sub> levels downwind from the sources can also be high provided NO is also present in sufficient quantity.

### **3. Criteria for RSPM/PM<sub>10</sub> Measurements**

One of the major sources of RSPM are vehicles especially diesel vehicles. Site for measuring RSPM should be located where number of such vehicle are high. Industrial sources such as combustion processes also contribute to ambient RSPM levels and RSPM measurements should also be conducted near such industrial activities.

### **4. Criteria for SPM Measurements**

The major sources of SPM include soil borne dust, dust originating from construction activities, resuspension of dust etc. In general the site for selecting stations for SPM should be located at areas where vehicle density is high and where high levels of SPM are expected.

### **5. Criteria for CO Measurements**

CO is emitted from vehicles and its measurement should be conducted near traffic intersections, highways, commercial areas with high traffic density. Generally areas with high population density also have high vehicles and higher CO levels and these areas should also be considered for conducting CO measurements

### **6. Criteria for Ozone Measurements**

Ozone is secondary pollutant and is formed in atmosphere by reactions of other pollutants such as NO, HC. Ozone precursors react to form ozone such that peak levels

are observed at locations downwind of the sources. Thus ozone stations should be located downwind from the sources. The inlet of the sampling probe of the ozone analyzer should be positioned 3 to 15 meters (10 to 49 feet) above ground, at least 4 meters (13 feet) from large trees, and 120 meters (349 feet) from heavy automobile traffic and sampling probes should be designed so as to minimize O<sub>3</sub> destruction by surface reaction or by reaction with NO (USEPA, 1986).

At ground level, the ambient atmosphere is inhomogeneous as a result of a continuous influx of fresh emissions, incomplete mixing, and destruction of O<sub>3</sub> by fresh and unreacted emissions and destruction on surfaces and thus density of monitoring stations should be more otherwise air quality at discreet locations may not represent temporal and spatial variations (USEPA, 1986).

#### **4.2.4 Sampling Duration and Frequency**

The period and frequency of sampling should be such that statistically reliable averages can be obtained with the data. National Ambient Air Quality Standards states that annual average should be computed of 104 measurements taken twice a week of 24 hours duration. One of the objective of monitoring under NAMP is to determine compliance to the NAAQS so monitoring should be done for 24 hours and minimum 104 days in a year.

The pollutants vary diurnally and seasonally and these variations should be taken into account for determining frequency of sampling. The precision required in the data is also important in determining frequency of sampling. Sampling should be more frequent than the frequency of variation of pollutants.

Particulate matter levels are lower during the monsoon months due to removal by wet deposition. Air pollutants such as CO levels are higher during winter months due to lower mixing heights resulting in less volume of troposphere available for mixing and hence higher concentrations. Thus measurements should be conducted in all the seasons so that in annual average all the seasons are represented equally. In general minimum 20% of the reading should be taken in each season.

#### **4.2.5 Measurement Methods**

NAAQS states the measurement methods for various pollutants. These methods should be used for conducting ambient air quality measurements. Selecting the method among the various options depend upon the resources available to sustain the measurement over a long time, detection limit of the methods, degree of skill required etc. Automatic analysers are often costly and need skilled manpower to operate them. Measurement of pollutants by wet chemical methods is fairly simple. The detection limit of the method should be lower than the expected concentrations in an area.

Instruments used for the air quality monitoring should be easy to use, calibrate and require minimum maintenance. Automatic analysers are costly and require skilled

manpower and needs to be calibrated very frequently depending upon how often the calibration parameters change. Measurement of Sulphur dioxide (SO<sub>2</sub>), and Nitrogen dioxide (NO<sub>2</sub>) by wet chemical method is fairly simple and can be employed easily in India. High Volume Sampler is being widely used for particulate matter measurement in India. Measurement method of SO<sub>2</sub>, NO<sub>2</sub>, RSPM, SPM, CO, ozone is given in Annexure –II.

The following precautions must be followed in analysis of air pollutants

1. Properly clean glassware must be used.
2. One set of glassware must be calibrated as per requirement
3. All critical chemicals used must be of analytical grade
4. Double distilled or nanopure water must be used for preparation of reagents and analysis.
5. Glassware and storage bottles must be rinsed with distilled water and chemicals respectively.
6. Reagent bottles must be properly marked by name, strength and date of preparation, expiry date and initial of chemist who has prepared the reagent.
7. Desiccant in the dessicator must be changed as per requirements
8. The chemicals whose strength changes with time must be standardised before use.
9. Calibration graphs must be made every time a new stock solution is prepared.
10. Reagent bottles must be made air tight before storage.
11. Key reagents must be prepared fresh on the date of analysis.
12. Storage of chemicals must be done as per recommendations like away from sunlight etc.
13. Active silica gel bottles with holes must be placed inside the weighing chamber.
14. The analytical balance must have a sensitivity of 0.1 mg or better.

#### **4.2.6 Meteorological Measurements**

Meteorology plays a significant role in study of air pollution and it is necessary to measure meteorological parameters. The essential meteorological parameters that should be measured are wind speed and direction, ambient air temperature, relative humidity, rainfall, atmospheric pressure and mixing height. Details of the meteorological instrument and method of measurement is given in Annexure – II. Anemometer is used to measure velocity of air, wind vane is used to measure wind direction, precipitation gauge or rain gauge is to measure rainfall and precipitation, thermometer is used to measure temperature, dry and wet bulb hygrometers, sling psychrometers is used to measure humidity in the air. SODAR is used to measure mixing height.

The wind data i.e. speed, direction and intensity are graphically represented by a diagram called wind rose diagram. Humidity is measured in terms of Relative Humidity which is the percentage of moisture present in the air, complete saturation being taken as 100. The greater the “RH” more the air is saturated. The RH below 30% is also unpleasant which can cause, drying of mucous, soar throat and cough. Moisture indicates the potentiality for fog formation in relation to the degree of air pollution.

### **4.2.7 Laboratory requirements**

The samples collected from site are analysed in the laboratory. If possible a kiosk can be constructed at the site and common laboratory apparatus such as refrigerator, balance, oven, spectrophotometer etc. can be kept at the site so that the collected samples can be analysed at the site and the losses due to improper sample preservation, transportation can be minimised. However, enough space must be available with sufficient power at site. If constructing a kiosk at site is not possible then the samples must be properly preserved and transported to the laboratory for analysis. The laboratory instrument must be calibrated regularly so as to minimise errors.

### **4.2.8 Quality assurance**

In India a nationwide network would involve large number of monitoring agencies that would conduct monitoring at number of locations in India. The quality assurance programme aims at achieving comparability of data from various agencies. Quality assurance can be within laboratory quality assurance programme. Internal quality assurance may be understood to include normal internal procedures such as periodic calibrations, duplicate checks, split samples, spiked samples and the keeping of adequate and neat records (WHO, 1977). External quality assurance may be taken to include those activities that are performed on a more occasional basis, usually outside the normal routine operations, e.g., on-site system surveys, independent performance audits, interlaboratory comparisons, and periodic evaluation of internal quality assurance data (WHO, 1977). The quality assurance procedures are described in detail in the next chapter.

### **4.2. 9 Data Handling and Presentation**

Air quality depends on the physical characteristics of the area and the site observations must be recorded so that data interpretation can be easier. Site observations can be type of area, whether residential, industrial, sensitive or traffic intersections, distance from nearby sources, whether location is in a market place etc. Height of instrument above ground level should also be recorded. The data should be validated by rejecting erroneous data, applying corrections as per the calibrations performed of flow rates etc. The data should be recorded on the prescribed formats. The sample of format for recording data is shown in Annexure-III. Software programs have been developed for doing data entry in dBase and analysis is done using FoxPro. The data presentation should be such that the objectives of monitoring are met. One of the objective of monitoring is to determine compliance to NAAQS so 24-hourly average and annual average should be computed as NAAQS are given for these averages except for CO where 8 –hourly and 1-hourly averaging should be performed. 98<sup>th</sup> percentile should be calculated as the NAAQS states that 24-hourly standard can be violated 2% of the times but not on two consecutive days. One of the objectives is to understand scavenging behaviour of environment. It is known that particulate matter is scavenged from the environment during monsoons and in order to understand seasonal variations, monthly

averaging should be done and plotted. Best fit lines should be plotted to determine trends in air quality.

The following must be followed for reporting data

- (i) The values should not be reported below the detection limit as per the method.
- (ii) SPM/RSPM values which are very high should be reported in round figures (without decimal place).
- (iii) Any outlier values found should be checked for contamination of sample, sudden change of environmental conditions in the vicinity of the monitoring site etc. and discarded if necessary.

#### 4.2.10 Financial Requirements

The essential requirements for conducting air quality measurements is the resource requirements in terms of personnel, infrastructure in the field and lab, equipment and finance etc. Enough resources should be available for purchase of instruments, hiring of manpower, establishing laboratory etc. Field staff having chemistry background preferably be employed for field work and laboratory analysis. The work of chemist and field staff should be supervised by a scientist who may also be involved in the interpretation of the data. An example of parameters that needs to be considered for estimating capital cost and operation and maintenance cost is as follows:

**Table 4.5: Operation and Maintenance cost of monitoring stations**

S. No.	Items
<b>Recurring costs</b>	
1	a) Filter paper:
2	b) Chemicals:
3	c) Glassware
4	d) Contingencies
5	e) Transportation
<b>Manpower</b>	
1	a) Salary of JSA
2	(a) Salary of JLA/FA

**Table 4.6: Capital Cost Of Establishing Stations.**

S. No.	Item Description
1.	Respirable Dust Sampler/ Instruments
2.	Automatic meteorological parameter monitoring instrument capable of measuring wind speed, direction, relative humidity, atmospheric pressure and temperature
3.	Balance
4.	Refrigerator
5.	Oven
6.	Spectrophotometer
7.	Dessicator
8.	Spare air blowers

#### **4.2.11 Manpower Requirement**

The manpower employed in monitoring should be competent to carry out field and laboratory work. Personnel with science background with MSc in environmental sciences, chemistry should be engaged in monitoring. The personnel employed should be aware of the various Environmental Acts, Rules and notifications thereunder and should be have knowledge of statistical tools for analysing and compiling data. The personnel should have knowledge of environmental chemistry and behaviour of air pollutants so as to carry out interpretation of data. The field monitoring is carried out by field assistants and these field assistants should be MSc in environmental chemistry. Laboratory analysis is generally carried out by Junior Scientific Assistant (JSA) and JSA should be PhD or MSc with relevant experience. Data entry and analysis is normally carried out by Data entry operator and JSA. Data entry operator should have requisite qualification such as Diploma in Software applications etc.

#### **4.2.12 Operation of Air Quality Monitoring Equipments**

The operation of high volume sampler for measuring SPM is described below. The procedure of sampling for gaseous pollutants, meteorological parameters is described in details in the measurements methods in Annexure – II.

##### **(a) Field Sampling**

Tilt back the inlet and secure it according to manufacturer's instructions. Loosen the face-plate wing-nuts and remove the face place. Remove the filter from its jacket and center it on the support screen with the rough side of the filter facing upwards. Replace the face-plate and tighten the wing-nuts to secure the rubber gasket against the filter edge. Gently lower the inlet. Inertial jet and cyclonic inlets must have their seals in contact with the top of the face-plate. Look underneath the inlet just as it is coming into contact with the face-plate to assure that this contact is being made. It may be

necessary to readjust the position of the filter/motor assembly in the sampler housing to obtain such a seal. Excessively windy and wet conditions should be avoided when changing samples. Pre-loading in a filter cartridge assembly, temporary removal of the sampler to a protected area, or a wind or rain shield may be used if, the sample must be changed in inclement weather. Set the timer for the desired start and stop time. Replace the chart paper in the flow recorder, if there is one, set the proper time, and mark the time and date on the chart. For a manually flow controlled sampler turn on the motor for five minutes and measure the exhaust pressure with a pressure gauge or rotameter. Read the flow rate corresponding to this exhaust pressure from the calibration curve and record it on the data sheet. Turn off the motor and assure that the timer is in its automatic mode. For automatically flow-controlled units, record the designated flow rate on the data sheet. Record the reading of the elapsed time meter. The specified length of sampling is commonly 8 hours or 24 hours. During this period, several reading (hourly) of flow rate should be taken.

After sampling is complete, record the final flow rate and the elapsed time in the same manner. Subtract the initial elapsed time from the final elapsed time to determine the sample duration. Remove the face-plate by removing the wing-nuts. Fold the filter in half lengthwise by handling it along its edge with the exposed side inward. Insert the filter in its jacket. Note the presence of insects on the deposit, loose particles, non-centered deposits, evidence of leaks, and unusual meteorological conditions on the data sheet. Mark the flow recorder chart, if any, and return it with the data sheet.

The following precautions must be followed in sampling of air pollutants

- a) The high volume sampler (HVS)/respirable dust sampler (RDS) must be properly calibrated to get the correct flow rate.
- b) Corrective and preventive maintenance of the HVS/RDS must be done.
- c) The filter used sampling should be of good quality (having better mechanical stability, chemical stability, particle sampling efficiency, flow resistance, cost and availability etc.)
- d) Filter should be mounted properly on the support screen with the rough side of the filter facing upwards.
- e) The wing nuts should be tightened properly to avoid any leakage
- f) Weighing of filter paper must be done after conditioning in dessicator having active moisture absorbent.
- g) Weighing of filter paper must be done in balance having accuracy of 0.01 mg and silica gel bottle must be kept in weighing chamber to avoid error while weighing.

- h) Distilled water must be used in manometer tube and water must be changed every fortnightly and zero level must be checked every time.
- i) Shelter should be provided at the sampling site for protection of instruments during rainy season.
- j) Ice should be kept in the sampling tray during sampling to avoid evaporation loss and better absorption.
- k) Evaporation loss if any must be made up with distilled water.
- l) Proper preservation of samples must be done after sampling. Gaseous samples must be preserved properly in an ice box or refrigerator (below 5 ° C) prior to analysis.



## **5.0 QUALITY ASSURANCE AND QUALITY CONTROL IN AIR QUALITY MONITORING**

An analytical quality control program develops information which can be used to, evaluate the accuracy and precision of analytical data in order to establish the quality of the data; provide an indication of the need for corrective actions and to determine the effects of corrective actions.

### **5.1 Analytical Quality Control**

Analytical quality control (AQC) scheme is taken up at two levels as mentioned below:

#### **1. Within- laboratory AQC,**

It is necessary to check the accuracy of analytical results within laboratory. The various sequential stages involved are:

1. Choosing an analytical method suitably free from bias, and ensuring the complete and unambiguous description of that method.
2. Checking that satisfactory precision is obtained with the method.
3. Establishing a control chart as a continuing check on precision and some sources of bias.
4. Ensuring accuracy of standard solution.

#### **2. Between laboratory ( or Inter- laboratory) AQC**

In between laboratory ( or Inter- laboratory) AQC a group of laboratories has to achieve comparability of results by controlling the accuracy of each laboratory. Usually between-laboratory AQC should be conducted as soon as all laboratories have satisfactorily completed the within laboratory AQC tests.

AQC tests between laboratories are necessary for the following two reasons:

1. To test for possible bias caused by sources not already checked in within laboratory AQC.
2. To provide direct evidence that the required comparability of results between laboratories has been achieved.

Accuracy may deteriorate with time and hence subsequently regular tests are required as a continuing check on between laboratories bias. Interlaboratory proficiency testing of ambient air quality measurement methods is described below. A flow chart for approach to achieving accuracy of analytical results is shown in Figure 5.1.

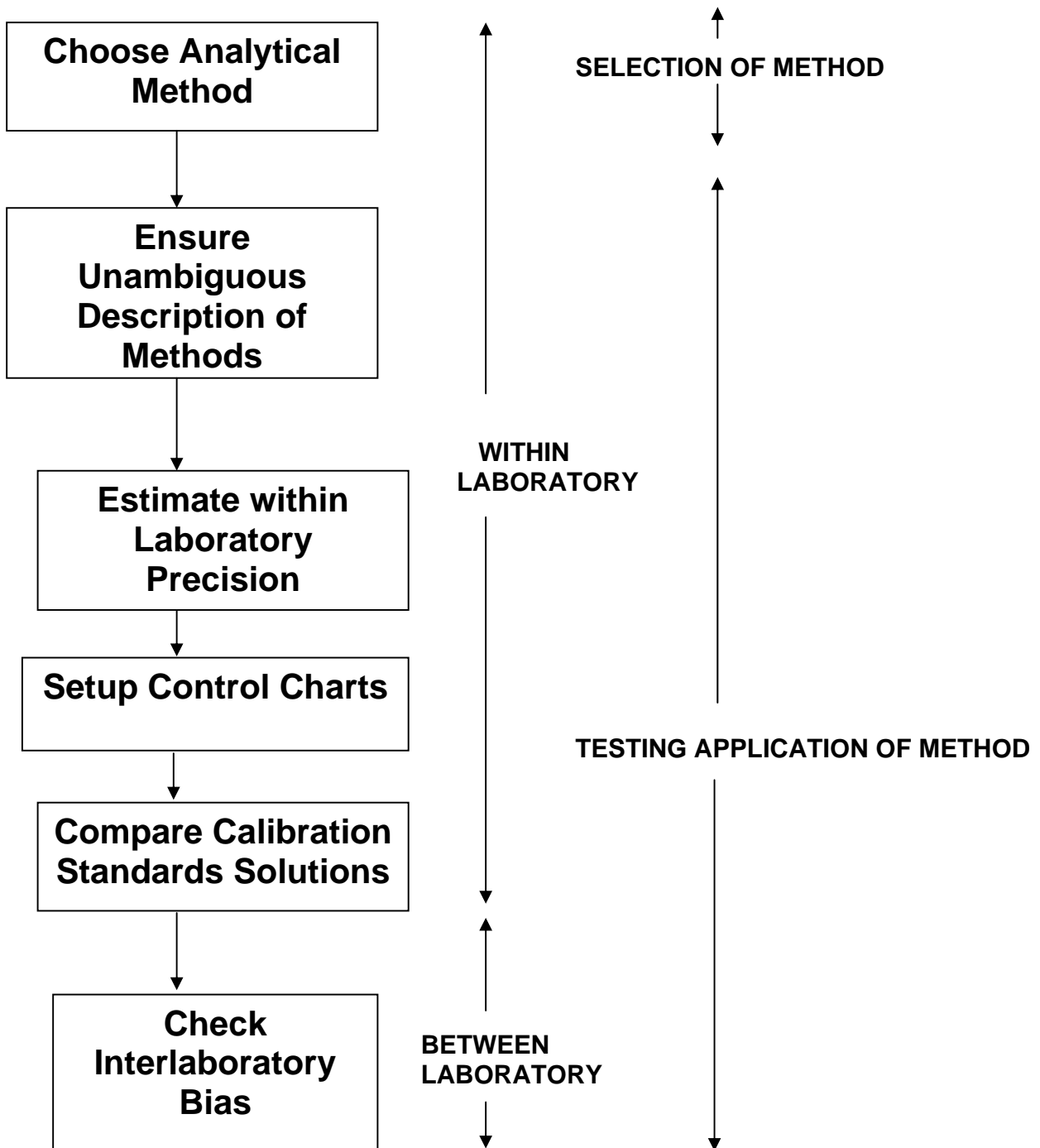

**Figure 5.1: Flow chart for approach to achieving accuracy of analytical results.**

## **(a) Inter Laboratory Proficiency Testing of Ambient Air Quality Measurement Methods**

Inter laboratory proficiency testing is a recognized tool for checking the capability of testing laboratories for producing reliable test results and judging the effectiveness of quality system/programme. Participating in proficiency testing programmes, involving inter laboratory test comparisons, provides valuable information with regard to the status of performance of laboratories participating in the programme. This in turn leads to efforts for identification of areas of weakness and measures to be taken for improvement.

Inter laboratory comparisons are conducted for a number of purposes and results may be used by participating laboratories and other parties.

Inter laboratory comparisons may be used, for example to:

- a) Determine the performance of individual laboratories for specific tests or measurements and to monitor laboratories continuing performance;
- b) Identify problems in laboratories and initiate remedial actions which may be related to for example, individual staff performance or calibration of instrumentation;
- c) Establish the effectiveness and comparability of new test or measurement methods and similarly to monitor established methods;
- d) Provide additional confidence to laboratory clients;
- e) Identify inter laboratory differences;
- f) Determine the performance characteristics of a method-often known as collaborative trials;
- g) Assign values to reference materials (RMs) and assess their suitability for use in specific test or measurement procedures.

### **1. Types Of Proficiency Testing**

Proficiency testing techniques vary depending on the nature of the test item, the method in use and the number of laboratories participating. It thus supplements laboratories own internal quality control procedures by providing an additional external measure of their testing capability. The performance of a laboratory depends on the quality system management of the laboratory. Major elements of the quality system are management of equipment staff, environment, test items, records, test methods and internal audits. The following are the common types of proficiency testing schemes.

### **(i) Measurement Comparison Schemes**

Measurement comparison schemes involve the test item to be measured or calibrated being circulated successively from one participating laboratory to the next. A reference laboratory provides assigned values for the test item, which might be a country's highest authority for the measurement concerned. It may be necessary for the best item to be checked at specific stages during the conduct of proficiency test. This is to ensure that there are no significant changes in the assigned value through out the course of the proficiency test.

### **(ii) Inter- Laboratory Testing Schemes**

Inter laboratory testing schemes involve randomly selected sub samples from a source of material being distributed simultaneously to participating testing laboratories for concurrent testing. After completion of testing, the results are submitted to the co-ordinating body and compared with the assigned value(s) to give an indication of the performance of the individual laboratories and the group as a whole. It is essential that the batch of the test items provided to participants in each round be sufficiently homogeneous so that any results later identified as extreme are not attributed to any significant test item variability.

### **(iii) Split-Sample Testing Schemes**

One special form of proficiency testing which clients of laboratories, including some regulatory bodies often use, is the technique of split-sample testing. Typically split-sample testing involves comparisons of the data produced by small groups of laboratories (often only two laboratories) which are being evaluated as potential or continuing suppliers of testing services. Split-sample testing schemes involve samples of a product or a material being divided into two or more parts with each participatory laboratory testing one part of each sample. They differ from inter laboratory testing schemes described earlier, as there are usually a very limited number of participating laboratories. Uses for this type of scheme include identifying poor precision, describing consistent bias and verifying the effectiveness of corrective actions. A similar technique of split-sample testing is also used in the monitoring of environmental and clinical laboratories. Typically these schemes involve the results from several split samples over a wide concentration interval being compared between an individual laboratory and one or more other laboratories. Under such schemes, one of the laboratories may be considered to be operating at a higher level (i.e. lower level of uncertainty) due to use of reference methodology and more advanced equipment etc. Its results are considered to be the reference values in such inter comparisons and it may act as an advisory or monitor laboratory to the other laboratories comparing split-sample datas with it.

## **2. Infrastructure for conducting Inter-Laboratory comparison on ambient air quality methods.**

The primary requirement for conducting inter-laboratory comparison on physical and chemical methods for measurement of air pollutants is depicted in Fig. 5.2.

This system is primarily known as Ring Test Facility. It mainly consists of several mass flow meters of different flow capacities. A mass flow controller, regulates these mass flow meters. Provision for producing the dilute air is done by means of compressor. The compressed air produced by the compressor is dried and purified by passing the air through silica gel and activated carbon respectively. The standard gas stored in steel cylinders is diluted to the desired concentration by the dilution air or zero air. It is difficult to store nitrogen dioxide in pressurised cylinders due to its unstable nature. Therefore nitric oxide stored in steel cylinders are converted to nitrogen dioxide by means of a process called Gas Phase titration (GPT). In order to attain GPT, nitric oxide is allowed to react with ozone ( produced by an ozone generator) to produce nitrogen dioxide. The ozone generator used for GPT can also produce desired ozone gas mixtures for calibration of continuous monitoring analysers and proficiency testing. In order to check the mixing of gas mixtures it is advisable to install the continuous monitoring analysers on the Ring Test Facility. The calibration of the continuous monitoring analysers is accomplished by means of static dilution system. The static dilution system is shown in Fig.5.3.

The standard gas mixtures produced by the Ring Test Facility are made available to different participants through a glass tube for inter-laboratory comparison exercises.

### **(i) Choice Of Method/Procedure**

Participants can use the method of their choice, which is consistent with routine procedures used in their laboratories. However, in certain circumstances, the coordinator may instruct participants to use a specified method. Such methods are usually nationally or internationally accepted standard methods, and will have been validated by an appropriate procedure ( e.g. collaborative trial).

Where calibration procedure is used, the assigned value will often be a reference value obtained from measurements obtained by a reputed calibration laboratory which should use a well defined and accepted procedure. It is desirable that participating laboratories use the same or similar procedure, but this will not always be practicable for calibration laboratories.

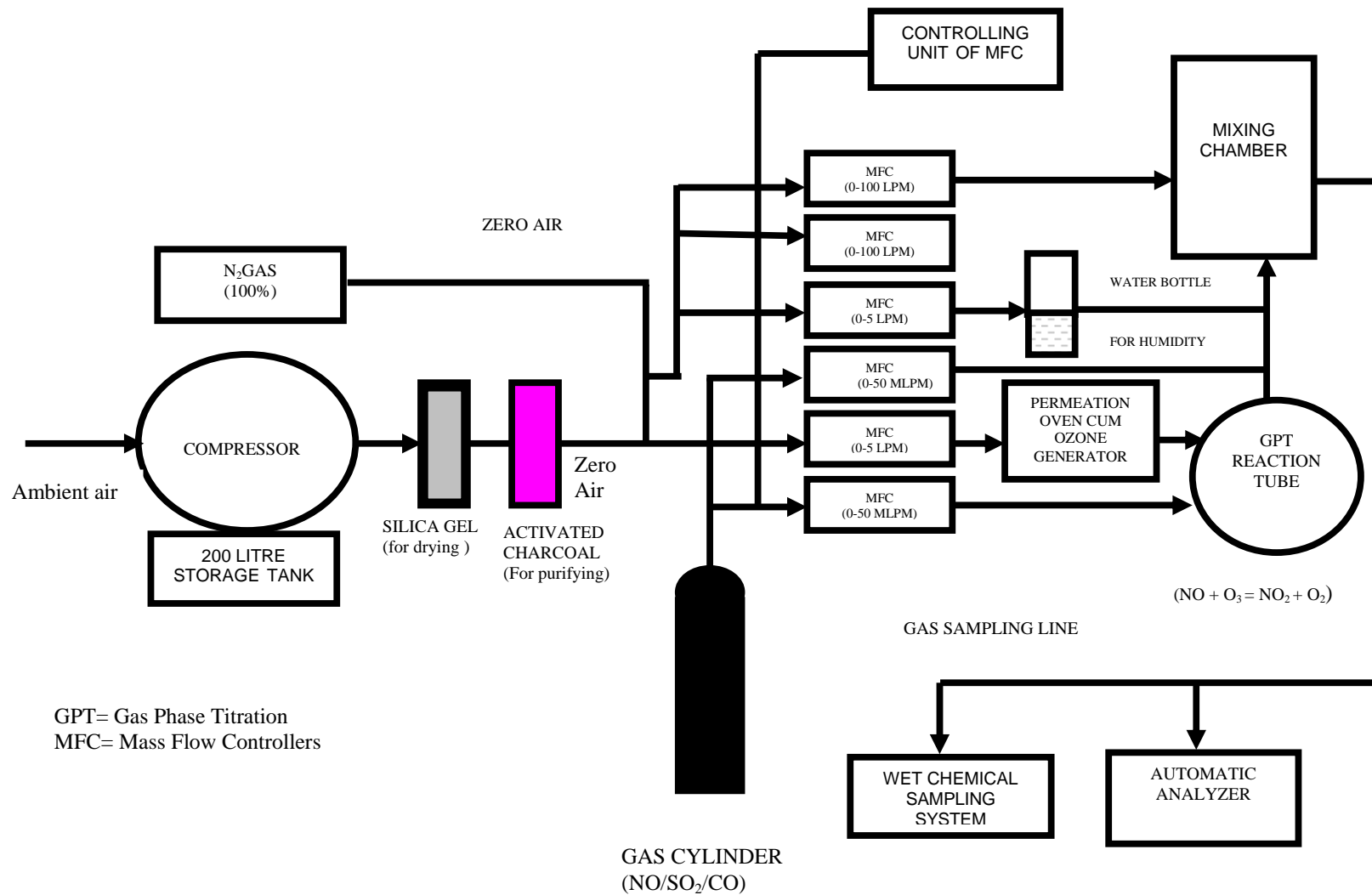

**Figure 5.2: Ring Test Facility.**

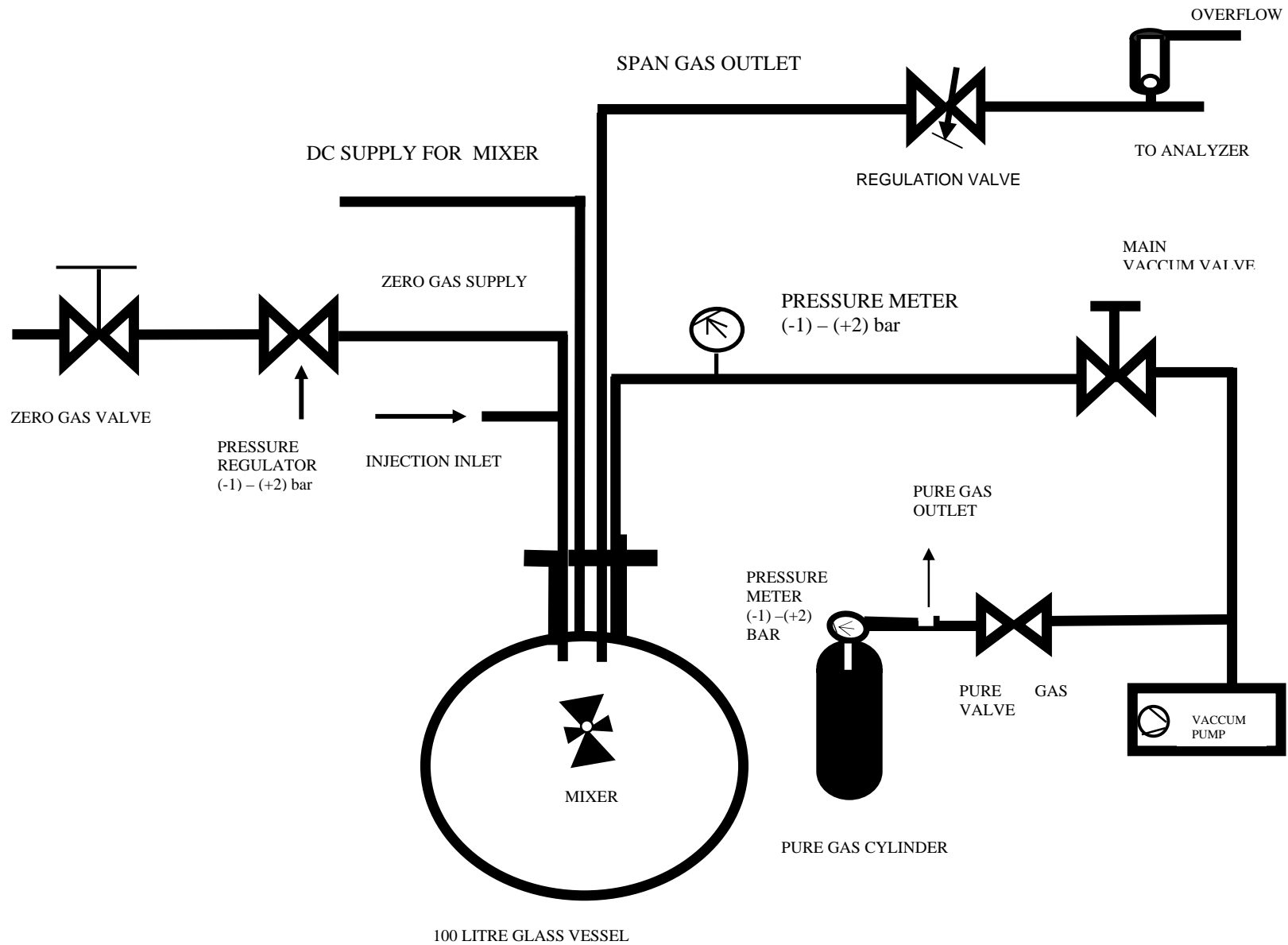

**Figure 5.3 Static Volumetric Dilution.**

## **(ii) Determination of the Assigned Value**

There are various procedures available for the establishment of assigned values. The most common procedures are listed below in an order that, in most cases will result in increasing uncertainty for the assigned value. These procedures involve use of:

- a) Known values- with results determined by specific test item formulation (e.g. manufacture or dilution).
- b) Certified reference value-as determined by definitive methods (for quantitative tests).
- c) Reference values:- as determined by analysis, measurement or comparison of the test item alongside a reference material or standard, traceable to a national or international standard.

## **(iii) Statistical Evaluation of Test Results**

Appropriate statistical design of a proficiency testing scheme is essential. Careful consideration is given to the following matters and their interaction.

- a) The precision and trueness of the test(s) involved;
- b) The smallest differences to be detected between participating laboratories at a desired confidence level;
- c) The number of participating laboratories;
- d) The number of samples to be tested and the number of repeat tests or measurements to be carried out on each sample;
- e) The procedure to be used to estimate the assigned value;
- f) Procedures to be used to identify outliers.

## **3. Benefits of Inter Laboratory Testing**

The direct benefits of participation of proficiency testing are

- It provides an objective means of assessing and demonstrating the reliability of the data they are producing
- Laboratories can claim that they can perform testing competently
- It supplements laboratories own internal quality control procedures by providing an additional external audit of the testing capability
- Laboratories can prove their testing capabilities to users that the results produced by them are reliable.

The results from proficiency testing programme are useful to the participating laboratories. Successful participation in specific programme may represent evidence of competence for that exercise. Similarly, unsuccessful performance may reflect a random departure from laboratory's normal state of competence. Participation in proficiency testing programme helps the laboratories to assess and demonstrate the reliability of the data they are producing. One of the main uses of the proficiency testing



is to assess its ability to perform tests competently. It thus helps to demonstrate its own quality system procedures. These also complement the technique of onsite laboratory assessment by technical assessors usually used by laboratory accrediting bodies. The accrediting bodies generally evaluate the quality system of the laboratory as per national and international criteria. Thus the proficiency testing gives a chance to the laboratory to evaluate its own quality system. In case the performance of the laboratory in the proficiency testing is not found satisfactory, the laboratory should find out its causes of inadequacy. Once the causes are analysed, it would be possible for the laboratory to identify the number of areas wherein improvement is needed. The laboratory should then be able to initiate appropriate action to improve its quality system for that testing in particular and as a whole for the organization.

### **5.1.1 Ring Test Facility at CPCB**

The Ring Test Facility as described by Dr. J. Kettenbach and Dr. S. Jacobi, HlfU 1997 is detailed below. The ring test-facility is laid out for a maximum number of 20 participants. The maximum sample flowrate is 250 l/min. To assure accurate mixing of gases as well as constant flowrates, the system is controlled by means of 8 mass flow controllers (MFC) of different ranges. Different sources (permeation tubes, highly concentrated gas standards from pressurized cylinders) can be used as primary reference gas standards.

To provide well known O<sub>3</sub> concentrations, an O<sub>3</sub> - generator along with a reaction chamber for "Gas Phase Titration" (GPT) is included. To check the influence of water vapour to the measurements, it is possible to add different amounts of moisture to the gas flow. All gas flows are controlled by means of high precision MFC's and are fed into a reaction or mixing chamber made out of glass. The outlet of this reaction chamber is distributed to all individual gas sampling exit ports via a glass tube of 27mm (ID). All parts which are in contact with the gas are made from glass or teflon ( ¼", 1/8") tubes.

#### **(i) Carrier Gas**

In general, different carrier gases for different trace gases (gas standards) are to be used. To achieve correct and clean NO-concentrations, N<sub>2</sub> is used as carrier gas. For all other gases, synthetic air should be used as carrier gas. MFC 1 and 2 are used to control the carrier gas supply. The range of each of those MFC's is 100 l/min. Therefore a maximum carrier gas flowrate of 200 l/min can be achieved. The controlled carrier gas supply is directly connected to the mixing chamber. MFC 3 ( range:0-50 l/min) is used to control the amount of water vapour added to the total gas mixture, if necessary. The separate flow of carrier gas via MFC 3 is passed through an impinger system filled with water. It is assumed that the gas stream is saturated by water vapour (relative humidity about 100%) after having passed the water reservoir through a fritted glass filter. To assure complete water vapour saturation, the level of water in the glass vessel must be at least 5 cm above the inlet of the gas into the water.

## **(ii) Dilution System**

The permeation system in combination with an O<sub>3</sub> – generator is manufactured within one 19 unit. The temperature of the permeation oven can be set alternatively to 40 or 50°C by using a switch on the front plate of the unit. The flowrate of diluent gas through the permeation system is controlled by MFC 4 ( range 0-5 l/min.) Synthetic air or purified and dried air from a compressor should be used as diluent gas for the permeation system. The exit of the permeation system is directly connected to the mixing chamber.

## **(iii) O<sub>3</sub> – Generator**

As mentioned above, the O<sub>3</sub> generator is part of the 19” unit of the permeation system. The generator in general consists of an UV- lamp ( length: 15” ) mounted into a glass-chamber. The voltage of the lamp and thus the intensity of radiation is controlled by a high precision potentiometer on the front plate. The flowrate through the O<sub>3</sub> – generator is controlled by MFC 5 (range: 0-5 l/min). Synthetic or purified and dried air from a compressor can be used.

The air must provide a constant fraction of O<sub>2</sub> which is not lower than 20%. The exit of the O<sub>3</sub> generator is connected to an injector T. The injector is used to add NO gas to facilitate the gas phase titration. The NO-gas is controlled by MFC 7 ( range: 0-50 ml/min). A teflon tube of 1 m length ( 6/4 mm OD/ID) is used as a reaction chamber where the GPT takes place. The exit of this GPT- reaction chamber again is connected to the main mixing chamber.

## **(iv) Generation of calibration gases using highly concentrated primary gas standards in pressurized gas cylinders ( e.g. SO<sub>2</sub> ,NO,CO).**

MFC 6 to 8 (ranges: 0-500,0-50 and 0-5 ml/min) can be used to hook up pressurized gas cylinders of various components as primary source to generate test or calibration gases. Typical mixing ratios used range from 100 to 1000 ppm. To achieve practical concentrations (also in the emission range), a suitable MFC (6-8) can be chosen depending on the concentration of the primary gas standard and the total gas flow.

## **(v) Gas Phase Titration (GPT)**

As a prerequisite for GPT, a constant flow of a well defined NO- concentration is needed. Turning on the UV-lamp and choosing an appropriate setting for lamp intensity and air flow, will give a sufficient source of O<sub>3</sub>. After mixing these two gas streams by means of the injector system, NO will be oxidized by O<sub>3</sub> quantitatively within the reaction chamber (teflon tube). Assuming a yield of 100% (quantitative reaction), the amount of NO<sub>2</sub> formed is identical to the original amount of O<sub>3</sub>.

The mixing ratio of O<sub>3</sub> (ppb) must not exceed 80% of the mixing ratio of NO (ppb). Only if these conditions are met, the reaction

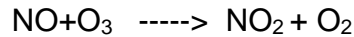

will consume the ozone completely.

### (vi) Basic Calculations

- General equation to calculate gas mixtures, using high concentrated calibration gases from pressurized cylinders as initial source:

$$C = C_v \cdot \frac{V_x}{(V_1 + V_2 + V_3 + V_4 + V_5 + V_6 + V_7 + V_8)}$$

- General equation to calculate gas mixtures, using a permeation tube system as initial source

$$C = \frac{PT}{(V_1 + V_2 + V_3 + V_4 + V_5 + V_6 + V_7 + V_8) \cdot F}$$

- General equation to calculate gas mixtures of O<sub>3</sub>, using an O<sub>3</sub> – generator as initial source:

$$C = \frac{C_{O_3}}{(V_1 + V_2 + V_3 + V_4 + V_5 + V_6 + V_7 + V_8)}$$

- General equation to calculate the relative humidity, in case the humidifier ( a simple gas bubbler or wash bottle) is used:

$$RH = 100 \cdot \frac{V_3}{(V_1 + V_2 + V_3 + V_4 + V_5 + V_6 + V_7 + V_8)}$$

### Legend

C: concentration of the corresponding gas after dilution (ppm, mixing ratio)

C<sub>v</sub> : concentration of the , “initial source”  
(ppm, mixing ratio of the calibration gas in pressurized gas cylinders)

C<sub>O<sub>3</sub></sub> : Source strength of the O<sub>3</sub> – generator ( ppm/l)

RH : Relative humidity (%)

PT : Permeation rate ( mg/min)

- F : factor to convert  $\text{mg}/\text{m}^3$  ( mass concentration) to ppm ( mixing ratio) under standard conditions ( T = 0° C; P = 1013 hPa)
- V<sub>1</sub> : V<sub>8</sub>: flow rate controlled by mass flow controller no. 1 to 8
- V<sub>x</sub> : Flow rate controlled by mass flow controller no. x (x= 6,7 or 8, corresponding to the supply of the initial calibration gas)

## 5.2 Reasons for Poor Quality of Data

The reasons for poor quality of data are as follows:

### (i) Irregular Calibration of Equipments

Monitoring instruments are prone to drift and may show variations in measured parameters. Calibration if not done regularly can decrease the accuracy of readings. Calibration of respirable dust sampler in terms of flow and time if not done regularly can result in errors in flow and time and hence errors in the concentrations.

### (ii) Improper Sample Collection, Preservation, Transportation and Analysis

Loss of samples can occur if they are not stored in ice box while transporting from field to laboratory and also if ice is not kept in ice tray while sampling. Data may not be comparable if analytical methods recommended by CPCB are not followed.

### (iii) Lack of Trained Manpower

Manpower if not trained properly may not follow correct methods of sampling and analysis resulting in error in measurements.

### (iv) Improper Location of Monitoring Station

If location of monitoring station is not representative of the area then data may not be useful for drawing any interpretation. If the location of the instrument is such that it does not satisfy the physical requirements of monitoring site such as height above ground level, distance from nearby sources etc. then data generated may not be of much use in determining status and trends.

### (v) Lack of Infrastructure

Infrastructure in terms of proper shed for the protection of instrument during rain, coveroff during off time if not provided may result in corrosion of instrument and error in data generated.

**(vi) Lack of Dedicated Manpower**

If due to shortage of manpower, personnel involved in ambient air quality monitoring are also involved in other activities and the monitoring data is not generated for adequate number of days, then the annual average computed may not represent the true annual average.

**(vii) Non-availability of Continuous Power Supply**

If due to non-availability of continuous power supply, monitoring is not carried out for 24 hours in a day, then the daily average computed may not represent true daily average.

### **5.3 Suggestions for Improvement**

The following suggestions are made to improve the quality of data

**(i) Calibration of Equipments**

Calibration of blower, rotameter and time totaliser must be carried out regularly depending upon use. Calibrated balance and spectrophotometer must be used in the laboratory. Facilities for calibration must be developed at recognised laboratories such as zonal offices of CPCB and SPCBs maybe asked to get their instruments calibrated at these laboratories. The calibration and auditing equipments are described below:

**(a) Calibration and Auditing Equipment**

- **Primary Flow Rate Standard** - A positive volume displacement device serves as a primary standard. A spirometer, a "frictionless" piston meter, or a Roots meter can serve as such a standard.
- **Orifice Transfer Standard** - The high volume sampler calibration orifice consists of a 3.175 cm (1.25 in) diameter hole in the end cap of 7.62 cm (13 in) diameter by 20.3 cm (8 in) long hollow metal cylinder. This orifice is mounted tightly to the filter support in place of the inlet during calibration. A small tap on the side of the cylinder is provided to measure the pressure drop across the orifice. A flow rate of 1132 l/min through the orifice typically results in a pressure difference of several inches of water. The relationship between pressure difference and flow rate is established via a calibration curve derived from measurements against a primary standard at standard temperature and pressure. Flow resistances that simulate filter resistances are introduced at the end of the calibrator opposite the orifice by a set of perforated circular disks.

- **Manometer** - A calibrated pressure gauge or water manometer spanning 0 to 15 inches of water (0-4 kPa) is used to determine the pressure drop across the orifice.
- **Barometer** - The atmospheric pressure at the time of calibration and at the time of measurement is determined with a barometer. Flow rate corrections are made if, these two pressures differ by more than 5 kPa (4% of standard 101.3 kPa).
- **Thermometer** - The atmospheric temperature at the time of calibration and at the time of measurement is determined with a thermometer. Flow rate corrections are made if, these two temperatures differ by more than 15°C (5% of standard 298 K).
- **Class-S Weights** - A 3 g standard mass of Class-S or Class-M quality is used to verify the span of the analytical balance
- **Analytical Balance** - Some analytical balances can be calibrated by the operator while others require specialized skills to re-calibrate. In general, analytical balances should be calibrated when first purchased, any time the balance is moved, at least every twelve months, or whenever an NBS traceable 3.0000 g weight registers outside  $\pm 0.5$  mg of its designated weight. At each weighing session a balance calibration check is performed using a Class S or Class M weight.

#### **(ii) Sample Collection, Transportation and Analysis**

Monitoring must be done twice a week for 24 hours so as to have 104 readings in a year. The results so obtained can be compared with NAAQS. Methods recommended by CPCB should be followed by all monitoring agencies so that results are comparable. Sophisticated instruments must be used for monitoring. The data must be reported in significant figures and must be compiled so that the comparison can be made with the National Ambient Air Quality Standards (NAAQS).

In case of sampling SO<sub>2</sub> and NO<sub>2</sub>, grease in the impingers must be put and ice must be kept in ice tray while sampling. The samples must be transported in ice tray so that no loss of samples occur while in transit. Evaporation losses must be made up by distilled water.

In case of SPM and RSPM sampling and analysis, pre and post conditioning of filter paper must be done. The other precautions as given in the previous chapter must be followed.

#### **(iii) Analytical Quality Control**

Analytical quality control must be exercised in the laboratory. Interlaboratory comparison exercises such as using Ring Test Facility at CPCB must be carried out regularly so that errors can be corrected.

#### **(iv) Training of Manpower**

Periodic training programmes and workshops must be arranged so that manpower involved in monitoring are familiarized with proper methods of sampling and analysis.

Site staff must be trained so that they are able to read rotameter, manometer properly, note down the time and carry out maintenance of blower, change of carbon brush etc. The laboratory staff must be trained so that uniform methods of analysis are followed in various laboratories making the results comparable. A uniform criteria must be fixed regarding qualification and experience of manpower engaged in the programme.

**(v) Infrastructure**

Proper shed such as pota cabin with telephone facility must be provided at site so that instrument can be protected during rains and other extreme weather conditions. Ice box and tool must be provided at site.

**(vi) Review Meetings**

Periodic meetings must be held among all the monitoring agencies to discuss and resolve problems faced in monitoring and also to review monitoring locations, frequency, addition or deletion of any parameter etc.

**(vii) Involvement of Other Monitoring Agency**

Local universities/ research institutions etc. may also be involved in ambient air quality monitoring to generate reliable data by sharing their experience in the field.

**(viii) Dedicated Manpower**

Dedicated manpower who are engaged only in ambient air quality monitoring must be involved in the programme so that monitoring is carried out for 104 days in a year as per the NAAQS.

**(ix) Power Supply**

Provision for uninterrupted power supply must be made so that monitoring can be carried out 24 hours in day.

**Table A1.1 NATIONAL AMBIENT AIR QUALITY STANDARDS (NAAQS)**

Pollutant	Time Weighted Average	Concentration in Ambient Air			Method of Measurement
		Industrial Area	Residential, Rural and other Areas	Sensitive Area	
Sulphur Dioxide (SO <sub>2</sub> )	Annual Average*	80 µg/m <sup>3</sup>	60 µg/m <sup>3</sup>	15 µg/m <sup>3</sup>	1. Improved West and Gaeke Method 2. Ultraviolet Fluorescence
	24 Hours Average**	120 µg/m <sup>3</sup>	80 µg/m <sup>3</sup>	30 µg/m <sup>3</sup>	
Oxides of Nitrogen as NO <sub>2</sub>	Annual Average*	80 µg/m <sup>3</sup>	60 µg/m <sup>3</sup>	15 µg/m <sup>3</sup>	1. Jacob & Hochheiser modified (NaOH-NaAsO <sub>2</sub> ) Method 2. Gas Phase Chemiluminescence
	24 Hours Average**	120 µg/m <sup>3</sup>	80 µg/m <sup>3</sup>	30 µg/m <sup>3</sup>	
Suspended Particulate Matter (SPM)	Annual Average*	360 µg/m <sup>3</sup>	140 µg/m <sup>3</sup>	70 µg/m <sup>3</sup>	High Volume Sampling (Average flow rate not less than 1.1m <sup>3</sup> /minute)
	24 Hours Average**	500 µg/m <sup>3</sup>	200 µg/m <sup>3</sup>	100 µg/m <sup>3</sup>	
Respirable Particulate Matter (Size less than 10µm) (RPM)	Annual Average*	120 µg/m <sup>3</sup>	60 µg/m <sup>3</sup>	50 µg/m <sup>3</sup>	Respirable Particulate Matter Sampler
	24 Hours Average**	150 µg/m <sup>3</sup>	100 µg/m <sup>3</sup>	75 µg/m <sup>3</sup>	
Lead (Pb)	Annual Average*	1.0 µg/m <sup>3</sup>	0.75 µg/m <sup>3</sup>	0.50 µg/m <sup>3</sup>	AAS Method after sampling using EPM 2000 or equivalent filter paper
	24 Hour Average**	1.5 µg/m <sup>3</sup>	1.0 µg/m <sup>3</sup>	0.75 µg/m <sup>3</sup>	
Carbon Monoxide (CO)	8 Hours Average**	5.0 mg/m <sup>3</sup>	2.0 mg/m <sup>3</sup>	1.0 mg/m <sup>3</sup>	Non dispersive Infrared Spectroscopy
	1 Hour Average	10.0mg/m <sup>3</sup>	4.0 mg/m <sup>3</sup>	2.0 mg/m <sup>3</sup>	
Ammonia (NH <sub>3</sub> )	Annual Average*	0.1 mg/m <sup>3</sup>			-
	24 Hour Average**	0.4 mg/m <sup>3</sup>			

\* Annual Arithmetic mean of minimum 104 measurements in a year twice a week 24 hourly at uniform interval.

\*\* 24 hourly/8 hourly values should be met 98% of the time in a year. However, 2% of the time, it may exceed but not on two consecutive days.

**NOTE**

1. National Ambient Air Quality Standard : The levels of air quality necessary with an adequate margin of safety, to protect the public health, vegetation and property.
2. Whenever and wherever two consecutive values exceed the limit specified above for the respective category, it would be considered adequate reason to institute regular/continuous monitoring and further investigations.
3. The State Government / State Board shall notify the sensitive and other areas in the respective states within a period of six months from the date of notification of National Ambient Air Quality Standards



# **1. AIR SAMPLING – GASEOUS**

## **1.0 TITLE**

Method for Air Sampling - Gaseous.

## **2.0 PURPOSE**

The purpose is to lay down a uniform and reliable method for the sampling of gaseous pollutants.

## **3.0 PRINCIPLE**

For determination of concentration of gaseous pollutant in air, it is necessary to obtain representative samples of air at a number of strategic points. The concentrations are likely to vary with time and distance from the source of pollution depending upon the nature of release, meteorological factors and local conditions such as topography and presence of buildings and vegetation. The measured concentrations are also known to depend upon the average time namely, the period of sampling. These aspects are required to be taken into account for sampling and interpretation of the measured values.

## **4.0 SCOPE**

This method of sampling is applicable to the gaseous pollutants in the air such as oxides of nitrogen and sulphur, ozone and other pollutants, which react with liquid absorbing reagents at atmospheric temperature and pressure when air is bubbled through the absorbing solution in the impinger.

## **5.0 INTERFERENCES**

The interferences are governed by the following factors.

5.1 Chemical changes such as chemical interactions among the components of the collected sample or photochemical decomposition.

5.2 Adsorption of the gases from the sample on to the walls of the container and leaks

5.3 The interval between collection and analysis of samples as short as possible, protect the samples from light and heat.

## **6.0 SAMPLE PRESERVATION**

After sample collection, the solutions must be stored at 5°C in a refrigerator.

## 7.0 APPARATUS

**7.1 Sampling equipment:** The sampling equipment to be used for air sampling will consist of a standard impinger of 35-ml capacity, a trap, a flow meter or critical orifice device and a suction pump. The arrangement of the sampling train is shown in the **(Figure 1)**. The commonly used apparatus is an integrated gas sampling assembly attached with High Volume Sampler or Handy Sampler.

**7.2 Sampling Train:** A typical sampling train consists of impinger, trap, flowmeter, valve and pump. Instead of this assembly critical orifice device can also be substituted. **(Figure- 1)**.

**7.2.1 Impingers:** All glass impingers, commonly called midget impingers are of 35 ml capacity 22cm in length and 2.6 cm wide, impinging end of the tube 1mm bore size or preferably with fritted disc having porosity of 50 microns or less. Details of two types of midget impingers are given in **(Figure 2 & 3)**. Units which use frits of approximately 50 microns or less pore size gradually become clogged with use. They may be cleaned by purging the appropriate cleaning solution back and forth through the frit and then rinsing with distilled water in the same fashion. Various substances may be removed from the frits by cleaning with the appropriate solvent namely; hot hydrochloric acid for dirt, hot concentrated sulphuric acid containing sodium nitrite for organic matter.

**7.2.2 Flowmeter:** A rotameter calibrated accurately for the flow ranges 0 to 3 litre/minute.

**7.2.3 Critical Orifice Device:** Critical orifice **(Figure 4)** to give a flow of about 1 litre/minute. Normally hypodermic needles are used as critical orifice devices.

**7.2.4 Trap:** This can be a glass wool tray or a membrane filter as shown in **Figure 1**.

**7.2.5 Volume Meters:** Volume meters may be of the wet type (wet test meters) or the dry type (diaphragm). The wet type gives the most precise result. The volume meters have the advantage that variation in rate of sampling will not introduce large error.

**7.2.6 Soap Bubble Meter:** Soap bubble meter is used to calibrate rotameter.

## 8.0 REAGENTS

All the reagents should be of A.R/G.R. grade.

**Fig. 1 Sampling Train**

**Fig. 2 Fritted Impinger for Air Sampling**

**Fig. 3 Standard Impinger for Air Sampling**

**Fig. 4 Critical Orifice Device**

## 9.0 PROCEDURE

**9.1 Sampling Location:** The sampling station should be selected so as to serve the exact purpose of investigation. For general city level it should be so located with respect to various sources, and the meteorological factors prevailing in the area that it gives a sample of pollution prevalent in the area reasonably repetitive. For local industrial pollution survey, it may be located to give maximum levels from that particular source.

The sampling station should have a free exposure, that it does not collect air from a stagnant pocket. It should be away from large buildings, which may interfere in free air circulation. It should be located at a height of minimum 1.5m but not exceeding 15m from the ground.

The sampling point should be such that it is not directly influenced by any local source emission meant for general study pollution level survey. For local investigation, it should be located to serve the exact purpose. Public buildings like city schools, laboratories, police stations, hospitals, municipal and government offices are more suitable because of their easy accessibility and security. The sample site should avoid contamination due to heavy automobile traffic or any such type of local effects.

**9.2 Number of Sampling Stations:** The number of stations in the sampling network will depend upon the purpose of investigation, availability of equipment and analytical facilities. Broadly, area survey and long term survey require a network, which is more or less uniformly distributed, preferably in a rectangular grid. Individual short-term surveys or spot surveys for single stations should be along the mean plume centre line as far as possible, backed by background readings from upwind regions.

**9.3 Sampling period:** Sampling period and rate of sampling shall vary with the type of sampling programme and its purpose. Normally the sampling periods are 30 minutes, one hour, one to four hours and eight hours depending upon the expected concentration of the pollutant, its nature and the investigation patterns. Based on practical experience the air sampling rates with respect to sampling period are as follows :

Period of Sampling	Rate of Sampling (Lit/min.)
30 minutes	2
1 hour	1
1-4 hours	0.5
8 hours	0.2-0.5
8-24 hours	0.1-0.2

**9.4 Sample collection:** Place 10 to 30 ml of the absorbing media in the impinger placed in an ice box and run the instrument as per the expected concentration of

the pollutant and accordingly select the sampling period and rate of sampling (Lit/min.). After completion of the sampling, remove the impingers, measure the sample volume. Either make up the sample volume or note the final volume of the absorbing solution. Preserve the samples as mentioned (7.0).

## 10.0 CALCULATIONS

The following equation is used for the calculation of gaseous pollutants in the ambient air.

$$\text{Concentration } (\mu\text{g}/\text{m}^3) = \frac{(\text{A}-\text{B}) \times \text{G.F} \times \text{Tv} \times 1000}{\text{T} \times \text{Fr} \times \text{Va}}$$

A	=	Absorbance of exposed sample at a particular wavelength.
B	=	Absorbance of reagent blank solution.
G.F	=	Graph factor of the concerned pollutant. ( $\mu\text{g}/\text{abs.}$ ) (Graph factor is the inverse of the slope)
Tv	=	Total volume of the exposed sample (ml)
1000	=	Conversion factor from litres to $\text{m}^3$
T	=	Total sampling time (min.)
Fr	=	Sampling flow rate (Litre/min.)
Va	=	volume taken for analysis (ml).

**Note:** T x Fr is equal to total volume of air in litres. The concentration of the gaseous pollutants can also be expressed in  $\mu\text{g}/\text{Nm}^3$  after correcting the total volume of air at 25°C temperature and 760 mm Hg pressure.

## 11.0 REFERENCES

1. Indian standard IS: 5182 (Part v) - 1975.
2. ASTM standard D1605 -60/90.
3. Methods of air sampling and analysis, Published by ISC, 37-42.

## **2. MEASUREMENT OF METEOROLOGICAL PARAMETERS**

### **1.0 TITLE**

Method for measurement of Meteorological Parameters.

### **2.0 PURPOSE**

The purpose is to lay down an uniform and reliable method for measurement of meteorological parameters in ambient air (humidity, temperature, wind speed, wind direction).

### **3.0 PROCEDURE INSTRUCTIONS**

Procedure instruction like, general information, set-up of the instrument, technical information (data), installation of the instrument, maintenance of the system and circuit diagram etc. is depicted in diagram I.

### **3.1 Meteorological Parameters**

#### **3.1.1 Humidity**

- (i) **General Information** - The water vapour in our air is called humidity. Since, in general, air is only partially saturated with water vapour, it is of great interest to determine the relative degree of saturation which is given in percent of maximum humidity. For many institutions such as hospitals, EDP rooms, meteorological measuring stations, museums, warehouses, green-houses etc., the exact knowledge and constant monitoring of the relative humidity is of great importance.

The hygro-transmitter, employed for such measurements, measures the relative humidity, displays the data and simultaneously provides an electrical signal.

- (ii) **Set-up of the instrument** - Specially prepared hair ("H") is used as a sensor. These hairs have undergone special treatment ("S-hygrofix") to make them react fast. The individual hairs which combine to make the measuring element, lengthen when the humidity increases and shrink when it decreases. The change in length is transferred to the rotary axis of a potentiometer. The slider and the scale indicator are also mounted onto this potentiometer. The external parts of the instrument are made of stainless steel (V2A).

Since the hygro-transmitters are adjusted uniformly, the plug and the cable can be exchanged at any time provided that the electrical output is the same.

Hair hygrometer are rarely used for field measurements these days, Modern Humidity Sensors use a capacitor sensor which has a di-electric that expands or contracts with change in humidity. This changes the capacitance which is sensed electronically.



**(iii) Technical Data**

Measuring range	:	10... 100% relative humidity
Accuracy	:	± 2% relative humidity
Length of scale	:	94 mm
Graduation	:	1% relative humidity
Load	:	Maximum 2 W
Slider current	:	Maximum 100 mA
Ambient temperature	:	-35... + 70°C
Weight	:	0.45 kg.

**Models Available**

Electrical outlet	:	Simple Double
Measuring element	:	H
Type of connection	:	S (Hygrofix) Lemososa plug 3 m cable
Electrical output	:	40-50-40 ohms 50-30-50 ohms 0...100 ohms 50-150-50 ohms 0...200 ohms 0...1000 ohms 0...2000 ohms 0...200 ohms lin.

**(iv) Installing the Instrument** - Install the hygro-transmitter in such a way that it is protected from jarring, dust, chemical impurities and splashing water. It can be mounted with the aid of the R 3/4" nuts directly to the wall of the room where the measurements are to be taken or can use the enclosed mounting angle to screw it to a plane surface. Please make sure that the transmitter is in the correct position for use - the immersion stem must be vertical and pointing downwards. Should there be heavily polluted air or wind velocities above about 3 m/s, then it will be necessary to employ a wind protection device in order to guarantee accurate measurements. This device is simply slipped over the immersion stem of the hygro-transmitter and turned so that the closed side faces the air stream.

Connect the electrical output of the hygro-transmitter to an appropriate display instrument (see circuit diagram). If, the hygro-transmitter has a double outlet, the second outlet can be used to connect a recorder or an additional display instrument. If, the hygro-transmitter has a Lemososa plug connection, then we recommend using a flexible pilot wire LiYY in the following models for the electrical connection :

No. of Poles (See Circuit Diagram)	Cross Section of Core	Total Diameter
5	0.25...0.38 mm <sup>2</sup>	5.2...5.7 mm
10	0.25...0.38 mm <sup>2</sup>	7.7...8.2 mm

- (v) **Maintenance** - In the interest of measuring accuracy, it is advisable to check out the display and to regenerate the hairs in saturated moist air from time to time. However, if there are only minor changes in humidity, it is sufficient to re-set the hairs, regeneration isn't necessary. Hygro-transmitters used in moist air with over 80% relative humidity do not require regeneration. Transmitters which are exposed to dry air frequently or over long periods of time must be regenerated more frequently. Hygro-transmitters which have not been regenerated will, in the course of time, start to indicate values which are about 5-8% too high. This degeneration can be reserved by exposing the hygro-transmitter to saturated moist air.

The easiest way to do this is to wrap the immersion stem of the hygro-transmitter for about 60 minutes in a damp cloth which has been dipped in lukewarm water. Make sure that the stem is completely enclosed in the cloth and that no air can get at it.

Normally, the indicator will settle at 94-96% relative humidity. If, there are significant deviations from this value, then correct this by means of the setting screw marked in red at the lower end of the stem. The hygro-transmitter which is correct at 95% relative humidity will also be correct and in accordance with the adjustment at all other humidities, provided that the characteristic hygrometric features of the hair have not changed as a result of damaging influences (heat, aggressive vapors, mechanical tearing etc.).

If, the hygro-transmitter is used with a wind protector, then it will be necessary to check this regularly. If, it is dirty, remove it from the instrument and clean it.

### 3.1.2 Temperature

- (i) **Hygro-thermo-transmitter** - Hygro-thermo-transmitters resemble the hygro-transmitters just described. They are equipped with an additional hard-glass resistor Pt 100 in the immersion stem. This resistor is suitable for use when long-range measurements of temperature with high resolutions are required.

The change in resistance in the platinum coiling as a result of changes in temperature is a measure of temperature. The relationship between resistance and temperature has been set down in DIN 43760. The term Pt 100 is the basic value of 100 ohm at 0°C.

Temperature measuring range	:	-30...+70°C
Measuring element	:	Pt 100 acc. to DIN 43760
Accuracy	:	DIN-tolerance 0.3° at 0°C
Self-heating error	:	0.11°C/mW
Time constant	:	28 s (90%)

### 3.1.3 Wind Speed

- (i) **Range of Application** - The combined wind sensor is designed to record wind values and to convert these values into electrical signals. The signals can be fed into a combined indicator which presents the wind velocity in a digital form and the wind direction in an analog form by means of a luminous diode chain.

The combined wind sensor can be used for velocities ranging from 0.3...40 m/s.

In order to prevent the formation of ice and frost during winter time use, the sensor is equipped with a electrical heater, which can be regulated with a thermostat.

The power supply unit supplies the heater with electricity.

- (ii) **Composition of the Instrument** - The instrument consists of the following parts :

- case
- cup anemometer
- wind vane
- connecting plug

(iii) **Technical Data**

Starting speed	:	0.3 m/s
Maximum stress	:	50 m/s
Sensitivity of response of the wind vane at 30° deflection	:	0.5 m/s
Damping of the wind vane	:	0.2
Measuring Range of Direction and Resolution	:	0...360°, 2.5°
Output speed	:	Impulses, low 0.5 V high 5 V
Output direction	:	8-bit special code : low 0.5 V high 15 V
Admissible Temperature Range (with heater)	:	-35°C...+60°C
Heater	:	75 W regulated by means of a thermostat
Switch-on and switch-off temperature	:	5.5°C ± 3°C on, 11°C ± 2.5°C off

Operating voltage		
	Electronic	: + 15 V/60 mA
	Heater	: 24 V/3 A
Connection		: 19 pol. Euchner plug
Case material		: GD-A1, sea waterproof
Transmission line		: LiCY 16x0.75, max. 0 20 mm, 100 m
lon		
Recomm. mast dimensions		: Threaded pipe 1 1/2" in accordance with DIN 2441
Dimensions		: See scale drawing ( <b>Figure-3</b> ).
Wind stress at 35 m/s		: Approx. 5 kp
Weight		: 3.2 kg

(iv) **Set-up and Mode of Operation** - Wind direction is detected by means of a highly sensitive light metal wind vane whose ball-bearing pivot is connected to a code drum. The casing of the code drum has a code pattern which can be scanned opto-electronically. The resolution of the code pattern amounts of 144 steps per 360°. An 8-bit binary information has been used i.e. the code drum has 8 scanning tracks. The Gray Code which counts up from 0...71 and down from 71...0 has been utilized. Seven tracks are required for this while the 8th track serves to differentiate between up and down. The scanning of the code pattern is carried out by means of optical reflective sensors where a diode emits an infrared ray which is reflected by the drum casing surface onto a photo-transistor.

The output voltage of the transistor depends on the position of the drum (the degree of reflection). The degree of reflection of the drum background is less than of the code pattern bus is still nonzero. A drop-page of the signal voltage below the lower trigger level indicates a malfunction of the corresponding scanner component and a warning signal is given. Alternatively a potentiometer direction sensor can be used where the wind vane is coupled to a 5 K potentiometer.

Opto-electronic semiconductor components are influenced by temperature fluctuations and by ageing. Thus, the diode current in the sensor must be adjusted so as to compensate for interference. For this purpose, an additional continuous tract is scanned and the output voltage is kept constant with the regulated diode current. If, transmission factor changes due to the influences of temperature or ageing, this will be automatically taken into account and the diode current will be readjusted. Wind velocity is recorded by means of a highly sensitive rotating cup anemometer whose ball bearing pivot is connected to a slotted drum. The slotted drum is also scanned opto-electronically.

The impulse frequency emitted is proportional to wind velocity. Just as was the case for the wind direction part, the output signal of the velocity sensor is electronically monitored to ensure that there is no malfunction of the scanner. (Installation of lightning rod No. 3100.99 is recommended in areas with frequent lightning activity).

**(v) Preparation for Use**

- (a) Selecting the Site of Operation** - In general, anemometers are designed to record wind conditions over a large area. In order to obtain comparable values for the determination of surface wind, measurements should be made at a height of 10 meters over open level terrain. Open level terrain is defined as an area where the distance between the anemometer and an obstruction amounts to at least 10 times the height of the obstruction. If, this condition cannot be met, then the anemometer should be set up at such a height where the measured values are, to the greatest extent possible, not influenced by local obstructions (approximately 6-10 meters above the obstruction).

The anemometer should be installed in the middle of flat roofs - not at the edge - in order to avoid a possible bias to one direction or the other.

- (b) Installing the Cup Anemometer** - Unscrew the cap nut and remove the deck plate from the velocity sensor case. Keep the rubber sealing ring in the protective cap. Install the cup anemometer in such a manner that the dowel pin (fitting pin) in the crossarms of the cup anemometer screws into the nut in the protective cap. Replace the deck plate and rescrew the cap nut. While doing this, hold the sensor by the protective cap not by the cup.

**3.1.4 Wind Direction**

- (i) Installing the Wind Vane** - Install the wind vane in the same manner as the cup. There is no deck plate.
- (ii) Installing the Sensor** - The sensor can be installed on a pipe of R 1 1/2" (48 mm) and 50 mm length. The internal diameter must amount to at least 36 mm since the sensor will be plugged into an electrical system at its base. Solder a flexible control line LiYCY with the required number of leads of 0.74 mm<sup>2</sup> onto the enclosed plug (see circuit diagram). The line resistance of the leads for the heater voltage of the sensor should not exceed 1 ohm - if necessary, connect several parallel leads.

A line resistance up to approximately 10 ohm is admissible for the signal connections. Following electrical connection, set the sensor on the pipe and make sure that the case markings face true north. (The bar must also point to the north). Fasten the instrument by means of the two hexagon cap screws on the shaft. (The electrical connections for the indicators should be carried out according to the circuit diagrams).

- (iii) Maintenance** - If, properly installed, the instrument requires no maintenance. (Severe pollution can lead to blockage of the slots between the rotating and stable parts of the sensor). Thus, it is recommendable to clean off accumulated dirt periodically. Certain symptoms of wear and tear can appear on the generator

bearings or on the ball bearings after years of use. One notices this because the starting torque is higher. If, such a defect occur, it is recommendable to return the instrument to the factory for repair.

**(iv) Accessories Available**

**(a) Telescopic mast for installing the sensor**

Length	Stress	Length
4m	3-fold	1.5 m
6m	3 fold	1.5 m
10m	6 fold,	1.5 m

Material : A1, sea waterproof  
 Diameter of mast pin : 49 mm  
 Max. Wind Stress : 60 m/s

**(b) Lightening rod to protect the sensor from destruction caused by lightening. The rod is placed below the sensor on the mast.**

Material : steel, hot dipped galvanized.

**(c) Grounding Set to ground the telescopic mast.**

Consists : Mast grounding clamp  
 Cross grounder  
 Cu-wire 5 mm, 1 m long  
 (Other special connecting instruments available on inquiry).

**4.0 REFERENCE**

1. Thies CLIMA, Adolf Thies, GMBH + CO. KG, GOOTTINGEN

## CIRCUIT DIAGRAM – 1

**CONNECTION EITHER**



**FIG. 1 (a) CIRCUIT DIAGRAM**

**FIG. 2(a) SCALE DRAWING**

### **3. DETERMINATION OF SUSPENDED PARTICULATE MATTER IN THE ATMOSPHERE (HIGH VOLUME METHOD)**

#### **1.0 TITLE**

Method for determination of Suspended Particulate Matter (SPM) in the atmosphere (High Volume Method).

#### **2.0 PURPOSE**

The purpose is to lay down an uniform and reliable method for measurement of Suspended Particulate Matter (SPM) in the ambient air.

#### **3.0 PRINCIPLE**

Air is drawn through a size-selective inlet and through a 20.3 X 25.4 cm (8 X 10 in) filter at a flow rate which is typically 1132 L/min (40 ft<sup>3</sup>/min). Particles with aerodynamic diameters less than the cut-point of the inlet are collected by the filter. The mass of these particles is determined by the difference in filter weights prior to and after sampling. The concentration of suspended particulate matter in the designated size range is calculated by dividing the weight gain of the filter by the volume of air sampled (1,2).

**3.1 Other Analysis** - Depending on the type of filter media used, filter samples can be analyzed for lead, iron, organic and elemental carbon, extractable organic material, elements, radioactive materials, inorganic compounds, and single particles.

#### **3.2 Range and Sensitivity**

**3.2.1 Lower Quantifiable Limit** - For a 24-h sample duration at 1132 L/min, the detection limit is determined by the reproducibility of the filter weight difference which shows a standard deviation (sigma) of approximately  $\pm 2$ mg. The three-sigma detection limit is then approximately 3.5  $\mu\text{g}/\text{m}^3$ . The three-sigma lower quantifiable limit depends on the filter used and may be as high as 5  $\mu\text{g}/\text{m}^3$ .

**3.2.2 Upper Quantifiable Limit** - For a 24-h sample duration at 1132 L/min, this limit is in the range of 400 to 1000  $\mu\text{g}/\text{m}^3$ . The exact value depends on the nature of the aerosol being sampled : very small particles will clog the filter at a relatively low mass loading while larger particles will fall off during sample transport at high concentrations.

#### **4.0 SCOPE**

This method is applicable for determination of suspended particulate matter in the ambient air.

## 5.0 INTERFERENCES

- 5.1 Passive Deposition** - Passive deposition occurs when windblown dust deposits on a filter both prior to and after sampling.
- 5.2 Inlet Loading and Re-Entrainment** - Material collected in size-selective inlets can become re-entrained in the sample flow. Controlled studies are insufficient to quantify this interference. It can be minimized by greasing or oiling inlet impaction surfaces, though this may change the size selective properties.
- 5.3 Re-circulation** - Re-circulation occurs when the blower exhaust, which contains carbon and copper particles from the armature and brushes, is entrained in the samples air. Positive biases of  $0.15 \mu\text{g}/\text{m}^3$  have been measured (4), which are insignificant mass interferences but which may affect carbon and copper measurements. Recirculation can be minimized by assuring a tight seal between the blower and the sampler housing (5) or by ducting blower exhaust away from the sampler.
- 5.4 Filter Artifact Formation** - Sulfur dioxide, nitrogen oxides, nitric acid and organic vapors can be absorbed on the filter medium along with the suspended particles thereby causing positive biases. Samples taken in the presence of high  $\text{SO}_2$  concentrations have been shown to yield up to  $10 \mu\text{g}/\text{m}^3$  of excess sulfate on glass fiber filters (6, 7)
- 5.5 Filter Conditioning** - Filter conditioning environments can result in different mass measurements as a function of relative humidity (RH). Soluble particles take on substantial quantities of water as RH increases, especially above the deliquescence point of approximately 70% RH (8). Increased mass deposits of 50% or more have been observed as RH increases to 100% (9). Twenty-four hours at a constant temperature and RH is considered adequate for sample equilibration.
- 5.6 Shipping Losses** - Particle loss during transport occurs when filters are heavily loaded with large dry aerosols. it is more prevalent on membrane than on glass fiber filters. Particle loss is minimized by shorter sample duration in heavily polluted environments, use of fiber as opposed to membrane filters, folding the filter prior to transport, and careful shipping procedures.
- 5.7 Precision and Accuracy**
- 5.7.1 Mass of the filter deposit, flow rate through the filter, and sampling time have typical precision of  $\pm 2 \text{ mg}$ ,  $\pm 5\%$ , and  $\pm 1 \text{ min}$ , respectively, as determined from performance tests (10). The accuracy of those measurements can be well within these tolerances when determined with independent standards. These uncertainties combine to yield a propagated precision of approximately  $\pm 13\%$  at  $10 \mu\text{g}/\text{m}^3$  and approximately  $\pm 5\%$  at  $100 \mu\text{g}/\text{m}^3$ . The filter deposit mass

measurement precision dominates at low concentrations while the flow rate precision dominates at high concentrations.

## 6.0 APPARATUS

**6.1 Sampler** - The essential features of a typical high volume sampler are shown in diagram of **Figure 1** and **2**. It is a compact unit consisting a protective housing, blower, voltage stabilizer, automatic time and time totalizer, rotameter, gaseous sampling assembly, filter holder capable of supporting a 20.3 x 25.4 cm. glass fibre filter.

## 6.2 Size Selective Inlets

**6.2.1 Peaked Roof Inlet (Figure-2)** - The peaked roof inlet is the oldest inlet and consists of a right triangular structure with an open hypotenuse placed over the filter. Over 50% of the particles smaller than 30  $\mu\text{m}$  to 50  $\mu\text{m}$  diameter penetrate this inlet (at 566 to 1698 L/min flow rates) and deposit on the filter (11,12). The peaked roof inlet does not have a sharp sampling effectiveness curve and is intended primarily to protect the filter from dust-fall. The sampling effectiveness of this inlet varies depending on its orientation with respect to wind direction and on the wind speed (11).

## 6.3 Flow Controllers

**6.3.1 Manual Volume Flow Control** - A variable voltage transformer placed in series with the blower controls the blower motor power. The motor speed varies with the voltage supplied, and the flow rate through a filter can be adjusted by increasing or decreasing the voltage to obtain the desired value for the resistance of the filter being used. The flow rate decreases as filter deposit increases, but this change is normally less than 10% and is quantifiable via pre- and post-exposure flow measurements.

## 6.4 Laboratory Equipment

**6.4.1 Controlled Environment** - A clean laboratory environment is required for filter inspection, equilibration, and weighing. A temperature in the range of 15 to 30°C with  $\pm 3^\circ\text{C}$  variability (4,16) and a relative humidity of 20 to 45% with  $\pm 5\%$  variability is recommended (4).

**6.4.2 Light Table** - A photographic slide viewing table is used for filter inspection.

**6.4.3 Analytical Balance** - The balance must be equipped with an expanded weighing chamber to accommodate 20.3 x 25.4 cm (8 x 10 in) filters and must have a sensitivity of 0.1 mg.

**FIG. 1 SKETCH DIAGRAM OF HIGH VALUME SAMPLER**

**FIG. 2 HIGH VALUME SAMPLER**

- 6.4.4 **Equilibration Rack** - This rack separates filters from one another so that the equilibration air can reach all parts of the filter surface. A photograph record rack serves this purpose well.
- 6.4.5 **Numbering Machine** - Though filter ID numbers can be written on the edge of filters with a pen, an incrementing numbering machine that prints 4 to 8 digit ID numbers is more efficient and is less likely to damage the filter.
- 6.4.6 **Wet Bulb/Dry Bulb Psychrometer** - The temperature and relative humidity of the controlled filter processing environment is measured and recorded before and after each filter processing session. Adjustments are made to the environmental control system when equilibration conditions exceed pre-set tolerances.

## 6.5 Calibration and Auditing Equipment

- 6.5.1 **Primary Flow Rate Standard** - A positive volume displacement device serves as a primary standard. A spirometer, a "frictionless" piston meter, or a Roots meter can serve as such a standard.
- 6.5.2 **Orifice Transfer Standard** - The high volume sampler calibration orifice consists of a 3.175 cm (1.25 in) diameter hole in the end cap of 7.62 cm (13 in) diameter by 20.3 cm (8 in) long hollow metal cylinder. This orifice is mounted tightly to the filter support in place of the inlet during calibration. A small tap on the side of the cylinder is provided to measure the pressure drop across the orifice. A flow rate of 1132 L/min through the orifice typically results in a pressure difference of several inches of water. The relationship between pressure difference and flow rate is established via a calibration curve derived from measurements against a primary standard at standard temperature and pressure. Flow resistances that simulate filter resistances are introduced at the end of the calibrator opposite the orifice by a set of perforated circular disks.
- 6.5.3 **Manometer** - A calibrated pressure gauge or water manometer spanning 0 to 15 inches of water (0-4 kPa) is used to determine the pressure drop across the orifice.
- 6.5.4 **Barometer** - The atmospheric pressure at the time of calibration and at the time of measurement is determined with a barometer. Flow rate corrections are made if, these two pressures differ by more than 5 kPa (4% of standard 101.3 kPa).
- 6.5.5 **Thermometer** - The atmospheric temperature at the time of calibration and at the time of measurement is determined with a thermometer. Flow rate corrections are made if, these two temperatures differ by more than 15°C (5% of standard 298 K).

6.5.6 **Class-S Weights** - A 3 g standard mass of Class-S or Class-M quality is used to verify the span of the analytical balance

6.5.7 **Analytical Balance** - Some analytical balances can be calibrated by the operator while others require specialized skills to re-calibrate. In general, analytical balances should be calibrated when first purchased, any time the balance is moved, at least every twelve months, or whenever an NBS traceable 3.0000 g weight registers outside  $\pm 0.5$  mg of its designated weight. At each weighing session a balance calibration check is performed using a Class S or Class M weight.

## 7.0 REAGENTS

7.1 **Filter Media** - A 20.3 x 25.4 cm (8 x 10 in) glass fiber filter is used to collect particles. The choice of filter type results from a compromise among the following filter attributes : (i) mechanical stability, (ii) chemical stability (iii) particle sampling efficiency, (iv) flow resistance, (v) clogging level, (vi) blank values (vii) artifact formation, and (viii) cost and availability. EPA filter requirements specify 0.3  $\mu\text{m}$  DOP sampling efficiency in excess of 99%, weight losses or gains due to mechanical or chemical instability of less than a 5  $\mu\text{g}/\text{m}^3$  equivalent, and alkalinity of less than 25 micro-equivalent/g to minimize sulfur dioxide ( $\text{SO}_2$ ) and nitrogen oxides ( $\text{NO}_x$ ) absorption (13). The most appropriate filter media for high volume sampling are cellulose fiber, glass fiber, quartz fiber, Teflon coated glass fiber, and Teflon membrane. None of these material is perfect for all purposes.

7.1.1 Glass fiber filters meet requirements in most categories with the exception of artifact formation and blank levels. Sampling efficiency is very high for all particle sizes (14,15). Blank levels for several elements of interest are high and variable (16,17). Glass fiber filters may exhibit organic carbon artifacts (18).

7.2 **Filter Jacket** - A smooth, heavy paper folder or envelope is used to protect the filter between the lab and field and during storage. Filter and sampling data are often recorded on the outside of the jacket, but this should not be done while the filter is in the jacket to prevent damage.

## 8.0 PROCEDURE

8.1 **Figure-3** presents a flow diagram of the routine operating procedure described in the following sub-sections.

8.2 **Filter Inspection** - Clean the light table surface with a methanol soaked wiper and allow it to dry. Filters should be handled with flowed hands to prevent contamination. Place each filter on the light table and examine it for pinholes, loose particles, tears, creases, lumps, or other defects. Loose particles may be removed with a soft brush. Filters not meeting visual criteria should not be used. If, chemical analyses are to be performed, one or two filters from each lot should



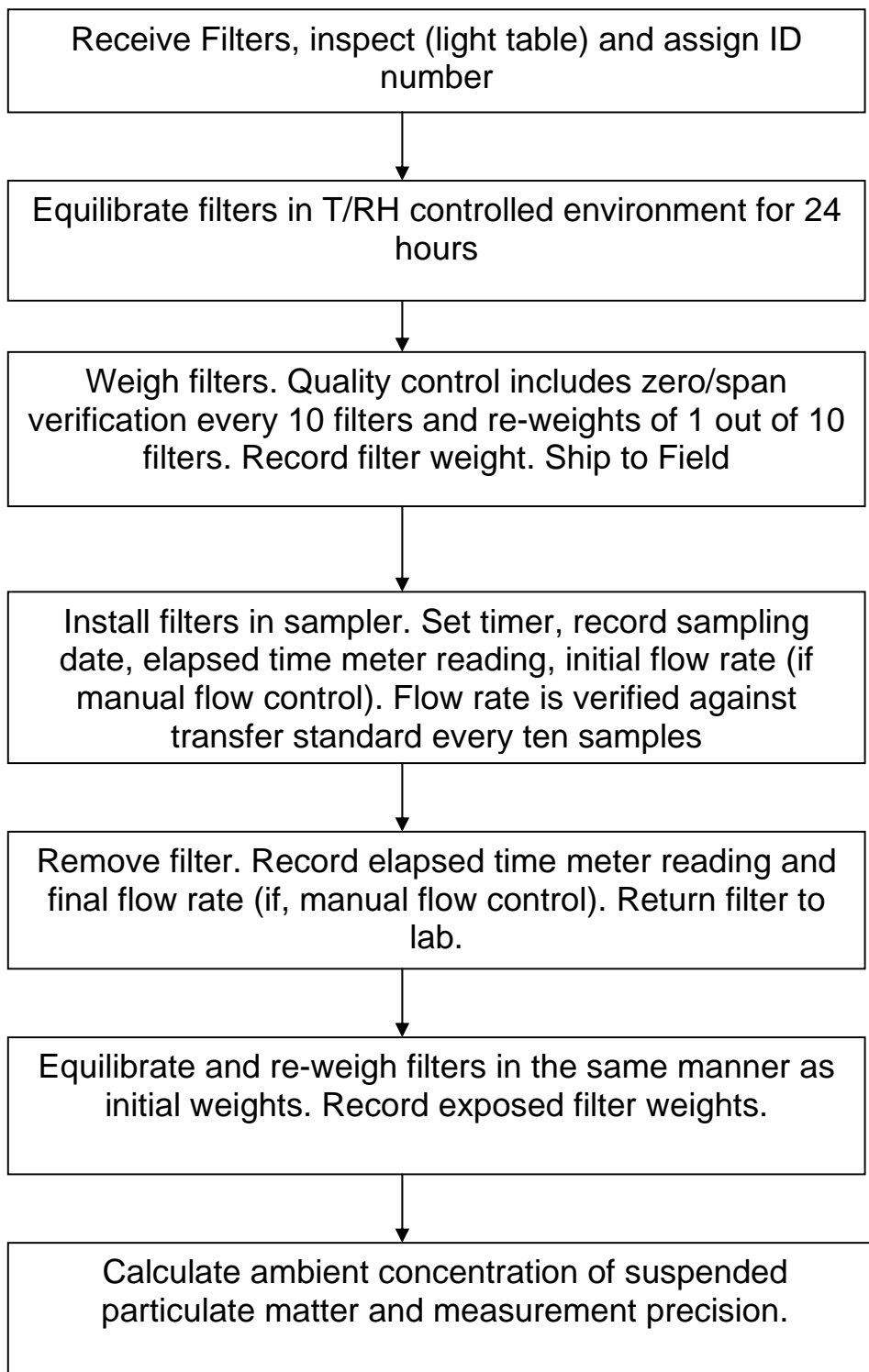

**Figure 3: Flow diagram for Routine Hivol Operations.**

be analyzed for blank levels and the lot should be rejected if, pre-set specifications are not met.

**8.3 Filter Identification** - Apply an ID number to the upper right hand corner on the smoothest side of each filter with the incrementing number machine. Gentle pressure must be used to avoid damaging the filter. Record this number in a chain-of-the custody log book and on a filter jacket. The chain-of custody log book contains columns opposite every filter ID to record dates and technician initials for filter inspection, equilibration, pre-weighing, shipment to field, receipt from field, re-equilibration, post-weighing and storage.

These records identify the disposition of each sample and prevent the creation of two samples with the same ID.

**8.4 Filter Equilibration** - Place blank or exposed filters in a storage rack in the controlled temperature and relative humidity environment (15 to 27°C and 0 to 50%, relative humidity) for 24 hours prior to weighing. The rack should separate filters such that all surfaces are exposed to the equilibration environment. Measure the temperature and relative humidity of the controlled environment and record the values in the equilibration column of the chain-of-custody log book.

**8.5 Filter Weighing** - It is best to weigh filters in groups of ten to fifty. Wear gloves for all filter handling. Stack filter jackets with data forms printed on them in the same order (in ascending order of filter ID numbers, if possible) as the order of filters in the equilibration rack. Adjust the balance tare to read zero with nothing in the weighing chamber and adjust the span to read (or verify that it reads) 3.00000 g with the 3 g standard weight on the weighing pan. Place a filter in the weighing chamber and adjust the balance to its equilibrium position. If, a stable reading cannot be obtained, it may be necessary to neutralize electrostatic charges with a radioactive source prior to and during weighing. Record the weight on the data form in the blank or exposed filter column. Verify the zero and span every ten filters. If, these differ from their normal values by more than  $\pm 1.0$  mg, read just them and re-weigh the previous ten filters. Place each filter in its filter jacket when weighing is complete, but do not seal the jacket opening. A separate technician randomly selects four filters or ten percent of all filters in the batch (whichever is larger), re-weigh them and subtracts this check-weight value from the corresponding routine weight. If, any check weight differs by more than  $\pm 4.0$  mg from the routine weight, re-weigh the entire batch of filters. Seal filter jackets and ship blank filters to the field or place exposed filters into storage.

**8.6 Field Sampling** - Tilt back the inlet and secure it according to manufacturer's instructions. Loosen the face-plate wing-nuts and remove the face plate. Remove the filter from its jacket and center it on the support screen with the rough side of the filter facing upwards. Replace the face-plate and tighten the wing-nuts to secure the rubber gasket against the filter edge. Gently lower the inlet. Inertial jet and cyclonic inlets must have their seals in contact with the top

of the face-plate. Look underneath the inlet just as it is coming into contact with the face-plate to assure that this contact is being made. It may be necessary to readjust the position of the filter/motor assembly in the sampler housing to obtain such a seal. Excessively windy and wet conditions should be avoided when changing samples. Pre-loading in a filter cartridge assembly, temporary removal of the sampler to a protected area, or a wind or rain shield may be used if, the sample must be changed in inclement weather. Set the timer for the desired start and stop time. Replace the chart paper in the flow recorder, if there is one, set the proper time, and mark the time and date on the chart. For a manually flow controlled sampler turn on the motor for five minutes and measure the exhaust pressure with a pressure gauge or rotameter. Read the flow rate corresponding to this exhaust pressure from the calibration curve and record it on the data sheet. Turn off the motor and assure that the timer is in its automatic mode. For automatically flow-controlled units, record the designated flow rate on the data sheet. Record the reading of the elapsed time meter. The specified length of sampling is commonly 8 hours or 24 hours. During this period, several reading (hourly) of flow rate should be taken.

After sampling is complete, record the final flow rate and the elapsed time in the same manner. Subtract the initial elapsed time from the final elapsed time to determine the sample duration. Remove the face-plate by removing the wing-nuts. Fold the filter in half lengthwise by handling it along its edge with the exposed side inward. Insert the filter in its jacket. Note the presence of insects on the deposit, loose particles, non-centered deposits, evidence of leaks, and unusual meteorological conditions on the data sheet. Mark the flow recorder chart, if any, and return it with the data sheet.

## 9.0 CALCULATIONS

### 9.1 Calculation of Volume of Air Sampled

$$\begin{aligned}
 V &= QT \\
 V &= \text{Volume of air sampled in m}^3 \\
 Q &= \text{Average flow rate in m}^3/\text{minute} \\
 T &= \text{Total sampling time in minute}
 \end{aligned}$$

### 9.2 Calculation of Suspended Particulate Matter in Ambient Air

$$\text{SPM} = \frac{(W_f - W_i) \times 10^6}{V}$$

Where :

$$\begin{aligned}
 \text{SPM} &= \text{Mass concentration of suspended particles in } \mu\text{g/m}^3 \\
 W_i &= \text{Initial weight of filter in g.} \\
 W_f &= \text{Final weight of filter in g.} \\
 V &= \text{Volume of air sampled in m}^3 \\
 10^6 &= \text{Conversion of g to } \mu\text{g.}
 \end{aligned}$$

## 10.0 REFERENCES

1. Robson, C.D. and K.E., Foster, 1962. Evaluation of air particulate sampling equipment. *Amer. Indust. Hyg. Assoc. Journal*, 23:404.
2. Olin, J.G. and J.L. Kurz, 1975. High volume air samplers. *Poll. Eng.* 7(1):30.
3. Rehme K.A., C.F. Smith, M.I. Fitzsimmons, 1984. "Investigation for use in the determination of of ambient particulate matter". 048, Research Triangle Park, N.C.
4. Countess. R.J., 1974. Production of aerosol by high volume samples. *J.Air Poll. Cont. Assoc.*, 24-605.
5. King, R.B. and J. Toma, 1975 "Copper emissions from a high volume air sampler". NASA Technical Memorandum, NASA-TM X-71693.
6. Coutant, R.W., 1977. Effect of environmental variables on collection of atmospheric sulfate. *Environ. Sci. & Tech.*, 11:875.
7. Appel. B.R., Y. Tokiwa. M. Haik and E.L. Kothny, 1984. Artifact particulate sulfate and nitrate formation on filter media. *Atmos. Environ.* 18:409.
8. Tang. I.N., 1980. Deliquescence properties and particle size change of hygroscopic aerosols. In *Generation of Aerosols and Facilities for Exposure Experiments*, edited by K. Willeke, Ann Arbor Science Publishers, Ann Arbor, MI.
9. Tierney, G.P., and W. Connor, 1967. Hygroscopic effects on weight determination of particulates collected on glass fiber filters. *Amer. Ind. Hyg. Journal*, 28:363.
10. Muller, P.K., G.M. Hudy, R.L. Baskett, K.K. Fung, R.C. Henry, T.F. Lavery, K.K. Warren and J.G. Watson, 1983. "The sulfate regional experiment : Report findings : Report EA-1901, Electric Power Research Institute, Palo Alto, CA.
11. Mcfari and. A.R., C.A. Ortiz and C.E. Rodes, 1979. Characteristics of aerosol samplers used in ambient air monitoring 86th National Meeting of the American Institute of Chemical Engineers, Houston. TX.
12. Wedding, J.B., A.R. Mcfart and J.E. Cermak, 1977. Large particle collection characteristics of ambient aerosol samplers. *Environ. Sci. & Tech.*, 4:387.
13. EPA, 1987. "40 CFR Part 53 : Ambient Air Monitoring Reference and Equivalent Methods". *Federal Register*, 52 FR 24724; "40 CFR Part 50 : Revisions to the National Ambient Air Quality Standards for Particulate Matter, Appendix J-Reference Method for the Determination of Particulate Matter as PM<sub>10</sub> in the

Atmosphere". Federal Register, 52 FR 24664 : "Ambient Air Monitoring Reference and Equivalent Methods : Reference Method Designation". Federal Register, 52 FR 37366 and 54 FR 45684.

14. Lippman, M. 1983. Sampling aerosols by filtration. In Air Sampling Instruments for Evaluation of Atmospheric Contaminants, 6th Edition, edited by P.J. Lioy and M.J.Y. Lioy, American Conference of Governmental Industrial Hygienists, Cincinnati, OH.
15. Schleien, B., J.A. Cochran and A.G. Friend, 1966. Calibration of glass fiber filters for particle size studies. Amer. Ind. Hyg. Assoc. Journal, 27:253.
16. Chow, I.C.A. Flaherty Watson, 1980. "Filter analysis development". EPA-90119-78-003.
17. Cadle, S.H., P.J. Grobh IAWA, 1983. Problems in the analysis of carbon particulate. Atmospheric.
18. Intersociety Committee. Methods of Air Sampling and Analysis (3<sup>rd</sup> Edition) by James. P. Lodge, Sr. Editor. Lewis Publishers, Inc.

## **4. MEASUREMENT OF RESPIRABLE SUSPENDED PARTICULATE MATTER (PM<sub>10</sub>) IN AMBIENT AIR (CYCLONIC FLOW TECHNIQUE)**

### **1.0 TITLE**

Method for measurement of Respirable Suspended Particulate Matter (PM<sub>10</sub>) in ambient air (Cyclonic Flow Technique).

### **2.0 PURPOSE**

The purpose is to lay down an uniform and reliable method for measurement of PM<sub>10</sub> (Particulate matter less than 10 µm diameter) in ambient air.

### **3.0 PRINCIPLE**

Air is drawn through a size-selective inlet and through a 20.3 X 25.4 cm (8 X 10 in) filter at a flow rate which is typically 1132 L/min. Particles with aerodynamic diameter less than the cut-point of the inlet are collected by the filter. The mass of these particles is determined by the difference in filter weights prior to and after sampling. The concentration of PM<sub>10</sub> in the designated size range is calculated by dividing the weight gain of the filter by the volume of air sampled.

**3.1 Other Analysis** - Depending on the type of filter media used, filter samples can be analyzed for lead, iron, organic and elemental carbon, extractable organic material, elements, radioactive materials, inorganic compounds, and single particles.

### **3.2 Range and Sensitivity**

**3.2.1 Lower Quantifiable Limit** - For a 24-h sample duration at 1000 L/min, the detection limit is determined by the reproducibility of the filter weight difference which shows a standard deviation (sigma) of approximately  $\pm 2$ mg. The three-sigma detection limit is then approximately 3.5 µg/m<sup>3</sup>. The three-sigma lower quantifiable limit depends on the filter used and may be as high as 5 µg/m<sup>3</sup>.

**3.2.2 Upper Quantifiable Limit** - For a 24-h sample duration at 1000 L/min, this limit is in the range of 400 to 1000 µg/m<sup>3</sup>. The exact value depends on the nature of the aerosol being sampled, very small particles will clog the filter at a relatively low mass loading while larger particles will fall off during sample transport at high concentrations.

### **4.0 SCOPE**

This method is applicable for measurement of PM<sub>10</sub> in the ambient air.

## 5.0 INTERFERENCES

**5.1 Passive Deposition** - Passive deposition occurs when windblown dust deposits on a filter both prior to and after sampling.

**5.2 Re-circulation** - Re-circulation occurs when the blower exhaust, which contains carbon and copper particles from the armature and brushes, is entrained in the sample air. Positive biases of  $0.15 \mu\text{g}/\text{m}^3$  have been measured, which are insignificant mass interferences but which may affect carbon and copper measurements. Recirculation can be minimized by assuring a tight seal between the blower and the sampler housing or by ducting blower exhaust away from the sampler.

**5.3 Filter Artifact Formation** - Sulfur dioxide, nitrogen oxides, nitric acid and organic vapors can be absorbed on the filter medium along with the suspended particles thereby causing positive biases. Samples taken in the presence of high  $\text{SO}_2$  concentrations have been shown to yield up to  $10 \mu\text{g}/\text{m}^3$  of excess sulfate on glass fiber filters.

**5.4 Filter Conditioning** - Filter conditioning environments can result in different mass measurements as a function of relative humidity (RH). Soluble particles take on substantial quantities of water as RH increases, especially above the deliquescence point of approximately 70% RH. Increased mass deposits of 50% or more have been observed as RH increases to 100%. Twenty-four hours at a constant temperature and RH is considered adequate for sample equilibration.

**5.5 Shipping Losses** - Particle loss during transport occurs when filters are heavily loaded with large dry aerosols. It is more prevalent on membrane than on glass fiber filters. Particle loss is minimized by shorter sample duration in heavily polluted environments, use of fiber as opposed to membrane filters, folding the filter prior to transport, and careful shipping procedures.

## 5.6 Precision and Accuracy

5.6.1 Mass of the filter deposit, flow rate through the filter, and sampling time have typical precision of  $\pm 2 \text{ mg}$ ,  $\pm 5\%$ , and  $\pm 1 \text{ min}$ , respectively, as determined from performance tests. The accuracy of those measurements can be well within these tolerances when determined with independent standards. These uncertainties combine to yield a propagated precision of approximately  $\pm 13\%$  at  $10 \mu\text{g}/\text{m}^3$  and approximately  $\pm 5\%$  at  $100 \mu\text{g}/\text{m}^3$ . The filter deposit mass measurement precision dominates at low concentrations while the flow rate precision dominates at high concentrations.

## 6.0 APPARATUS

6.1 **Sampler-** It is a compact unit consisting a protective housing, blower, voltage stabilizer, time totalizer, rotameter and filter holder capable of supporting a 20.3 x 25.4 cm. glass fibre filter.

### 6.2 Inlet for PM<sub>10</sub> Sampling

#### 6.2.1 Cyclonic Flow Inlet

Cyclones use centrifugal force to remove dust. A particle in a rotating air stream is subjected to a centrifugal force that accelerates it towards a surface where it will impact and lose momentum, thus being removed from air stream. In a typical cyclone pre-collector, the air enters tangentially at its side and swirls around inside. Particles above 10 μm are thrown to the cyclone walls and collected at its base ("grit-pot"). The air containing the respirable dust leaves through the central exit at the top of the cyclone and is filtered to collect the dust on a filter paper.

### 6.3 Flow Controllers

6.3.1 **Manual Volume Flow Control** - A variable voltage transformer placed in the circuit of the blower controls the blower motor power. The motor speed varies with the voltage supplied, and the flow rate through a filter can be adjusted by increasing or decreasing the voltage to obtain the desired value for the resistance of the filter being used. The flow rate decreases as filter deposit increases, but this change is normally less than 10% and is quantifiable via pre- and post-exposure flow measurements. For best results instruments with automatic flow control may be used.

### 6.4 Laboratory Equipment

6.4.1 **Controlled Environment** - A clean laboratory environment is required for filter inspection, equilibration, and weighing. A temperature in the range of 15 to 30°C with ± 3°C variability and a relative humidity of 20 to 45% with ± 5% variability is recommended.

6.4.2 **Analytical Balance** - The balance must be equipped with an expanded weighing chamber to accommodate 20.3 x 25.4 cm (8 x 10 in) filters and must have a sensitivity of 0.1 mg.

6.4.3 **Equilibration Rack** - This rack separates filters from one another so that the equilibration air can reach all parts of the filter surface. A photograph record rack serves this purpose well.



6.4.4 **Numbering Machine** - Though filter ID numbers can be written on the edge of filters with a pen, an incrementing numbering machine that prints 4 to 8 digit ID numbers is more efficient and is less likely to damage the filter.

6.4.5 **Wet Bulb/Dry Bulb Psychrometer** - The temperature and relative humidity of the controlled filter processing environment is measured and recorded before and after each filter processing session. Adjustments are made to the environmental control system when equilibration conditions exceed pre-set tolerances.

## 6.5 Calibration and Auditing Equipment

6.5.1 **Primary Flow Rate Standard** - A positive volume displacement device serves as a primary standard. A spirometer, a "frictionless" piston meter, or a Roots meter can serve as such a standard.

6.5.2 **Orifice Transfer Standard** - The PM<sub>10</sub> sampler calibration orifice consists of a 3.175 cm (1.25 inch) diameter hole in the end cap of 7.62 cm (13 in) diameter by 20.3 cm (8 in) long hollow metal cylinder. This orifice is mounted tightly to the filter support in place of the inlet or at the cyclone inlet during calibration. A small tap on the side of the cylinder is provided to measure the pressure drop across the orifice. A flow rate of 1132 L/min through the orifice typically results in a pressure difference of several inches of water. The relationship between pressure difference and flow rate is established via a calibration curve derived from measurements against a primary standard such as a rootsmeter at standard temperature and pressure. Flow resistances that simulate filter resistances are introduced at the end of the calibrator opposite the orifice by a set of perforated circular disks.

6.5.3 **Manometer** - A calibrated pressure gauge or water manometer spanning 0 to 15 inches of water (0-4 kPa) is used to determine the pressure drop across the orifice.

6.5.4 **Barometer** - The atmospheric pressure at the time of calibration and at the time of measurement is determined with a barometer. Flow rate corrections are made if, these two pressures differ by more than 5 kPa (4% of standard 101.3 kPa).

6.5.5 **Thermometer** - The atmospheric temperature at the time of calibration and at the time of measurement is determined with a thermometer. Flow rate corrections are made if, these two temperatures differ by more than 15°C (5% of standard 298 K).

6.5.6 **Class-S Weights** - A 3 g standard mass of Class-S or Class-M quality is used to verify the span of the analytical balance

6.5.7 **Analytical Balance** - Some analytical balances can be calibrated by the operator while others require specialized skills to re-calibrate. In general, analytical balances should be calibrated when first purchased, any time the balance is moved, at least every twelve months. At each weighing session, a balance calibration check is performed using a Class S or Class M weight.

## 7.0 REAGENTS

7.1 **Filter Media** - A 20.3 x 25.4 cm (8 x 10 in) glass fiber filter is used to collect particles. The choice of filter type results from a compromise among the following filter attributes : (i) mechanical stability, (ii) chemical stability (iii) particle sampling efficiency, (iv) flow resistance, (v) clogging level, (vi) blank values (vii) artifact formation, and (viii) cost and availability. United States Environmental Protection Agency (USEPA) filter requirements specify 0.3  $\mu\text{m}$  DOP sampling efficiency in excess of 99%, weight losses or gains due to mechanical or chemical instability of less than a 5  $\mu\text{g}/\text{m}^3$  equivalent, and alkalinity of less than 25 micro-equivalent/g to minimize sulfur dioxide ( $\text{SO}_2$ ) and nitrogen oxides ( $\text{NO}_x$ ) absorption. The most appropriate filter media for high volume sampling are cellulose fiber, glass fiber, quartz fiber, Teflon coated glass fiber, and Teflon membrane. None of these material is perfect for all purposes.

7.1.1 Glass fiber filters meet requirements in most categories with the exception of artifact formation and blank levels. Sampling efficiency is very high for all particle sizes. Blank levels for several elements of interest are high and variable. Glass fiber filters may exhibit organic carbon artifacts.

7.2 **Filter Jacket** - A smooth, heavy paper folder or envelope is used to protect the filter between the lab and field and during storage. Filter and sampling data are often recorded on the outside of the jacket, but this should not be done while the filter is in the jacket to prevent damage.

## 8.0 PROCEDURE

8.1 **Filter Inspection** - Clean the light table surface with a methanol soaked wiper and allow it to dry. Filters should be handled with flowed hands to prevent contamination. Place each filter on the light table and examine it for pinholes, loose particles, tears, creases, lumps, or other defects. Loose particles may be removed with a soft brush. Filters not meeting visual criteria should not be used. If, chemical analyses are to be performed, one or two filters from each lot should be analyzed for blank levels and the lot should be rejected if, pre-set specifications are not met.

8.2 **Filter Identification** - Apply an ID number to the upper right hand corner on the smoothest side of each filter with the incrementing number machine. Gentle pressure must be used to avoid damaging the filter. Record this number in a

chain-of-the custody log-book and on a filter jacket. The chain-of custody log book contains columns opposite every filter ID to record dates and technician initials for filter inspection, equilibration, pre-weighing, shipment to field, receipt from field, re-equilibration, post-weighing and storage.

These records identify the disposition of each sample and prevent the creation of two samples with the same ID.

- 8.3 Filter Equilibration** - Place blank or exposed filters in a storage rack in the controlled temperature and relative humidity environment (15 to 27°C and 0 to 50%, relative humidity) for 24 hours prior to weighing. The rack should separate filters such that all surfaces are exposed to the equilibration environment. Measure the temperature and relative humidity of the controlled environment and record the values in the equilibration column of the chain-of-custody log book.
- 8.4 Filter Weighing** - It is best to weigh filters in groups of ten to fifty. Wear gloves for all filter handling. Stack filter jackets with data forms printed on them in the same order (in ascending order of filter ID numbers, if possible) as the order of filters in the equilibration rack. Adjust the balance tare to read zero with nothing in the weighing chamber and adjust the span to read (or verify that it reads) 3.00000 g with the 3 g standard weight on the weighing pan. Place a filter in the weighing chamber and adjust the balance to its equilibrium position. If, a stable reading cannot be obtained, it may be necessary to neutralize electrostatic charges with a radioactive source prior to and during weighing. Record the weight on the data form in the blank or exposed filter column. Verify the zero and span every ten filters. If, these differ from their normal values by more than  $\pm 1.0$  mg, read just them and re-weigh the previous ten filters. Place each filter in its filter jacket when weighing is complete, but do not seal the jacket opening. A separate technician randomly selects four filters or ten percent of all filters in the batch (whichever is larger), re-weigh them and subtract this check-weight value from the corresponding routine weigh. If, any check weight differs by more than  $\pm 4.0$  mg from the routine weight, re-weigh the entire batch of filters. Seal filter jackets and ship blank filters to the field or place exposed filters into storage.
- 8.5 Field Sampling** - Tilt back the inlet and secure it according to manufacturer's instructions. Loosen the face-plate wing-nuts and remove the face plate. Remove the filter from its jacket and center it on the support screen with the rough side of the filter facing upwards. Replace the face-plate and tighten the wing-nuts to secure the rubber gasket against the filter edge. Gently lower the inlet. Inertial jet and cyclonic inlets must have their seals in contact with the top of the face-plate. Look underneath the inlet just as it is coming into contact with the face-plate to assure that this contact is being made. It may be necessary to readjust the position of the filter/motor assembly in the sampler housing to obtain such a seal. Excessively windy and wet conditions should be avoided when changing samples. Pre-loading in a filter cartridge assembly, temporary removal of the sampler to a protected area, or a wind or rain shield may be used if, the

sample must be changed in inclement weather. Set the timer for the desired start and stop time. Replace the chart paper in the flow recorder, if there is one, set the proper time, and mark the time and date on the chart. For a manually flow controlled sampler turn on the motor for five minutes and measure the exhaust pressure with a pressure gauge or rotameter. Read the flow rate corresponding to this exhaust pressure from the calibration curve and record it on the data sheet. Turn off the motor and assure that the timer is in its automatic mode. For automatically flow-controlled units, record the designated flow rate on the data sheet. Record the reading of the elapsed time meter. The specified length of sampling is commonly 8 hours or 24 hours. During this period, several reading (hourly) of flow rate should be taken.

After sampling is complete, record the final flow rate and the elapsed time in the same manner. Subtract the initial elapsed time from the final elapsed time to determine the sample duration. Remove the face-plate by removing the wing-nuts. Fold the filter in half lengthwise by handling it along its edge with the exposed side inward. Insert the filter in its jacket. Note the presence of insects on the deposit, loose particles, non-centered deposits, evidence of leaks, and unusual meteorological conditions on the data sheet. Mark the flow recorder chart, if any, and return it with the data sheet.

## 9.0 CALCULATIONS

### 9.1 Calculation of Volume of Air Sampled

$$\begin{aligned}
 V &= QT \\
 V &= \text{Volume of air sampled in m}^3 \\
 Q &= \text{Average flow rate in m}^3/\text{minute} \\
 T &= \text{Total sampling time in minute}
 \end{aligned}$$

### 9.2 Calculation of PM<sub>10</sub> in Ambient Air

$$\text{PM}_{10} = \frac{(W_f - W_i) \times 10^6}{V}$$

Where :

$$\begin{aligned}
 \text{PM}_{10} &= \text{Mass concentration of particulate matter less than 10 micron diameter in } \mu\text{g/m}^3 \\
 W_i &= \text{Initial weight of filter in g.} \\
 W_f &= \text{Final weight of filter in g.} \\
 V &= \text{Volume of air sampled in m}^3 \\
 10^6 &= \text{Conversion of g to } \mu\text{g.}
 \end{aligned}$$

## 10.0 REFERENCES

1. Intersociety Committee. Methods of Air Sampling and Analysis (3<sup>rd</sup> Edition) by James. P. Lodge, Sr. Editor. Lewis Publishers, Inc.

## **5. DETERMINATION OF SULPHUR DIOXIDE IN AIR (MODIFIED WEST AND GAEKE METHOD)**

### **1.0 TITLE**

Method for determination of Sulphur Dioxide in Air (Modified West and Gaeke Method).

### **2.0 PURPOSE**

The purpose is to lay down an uniform and reliable method for determination of sulphur dioxide (SO<sub>2</sub>) in ambient air.

### **3.0 PRINCIPLE**

Sulphur dioxide from air is absorbed in a solution of potassium tetrachloro-mercurate (TCM). A dichlorosulphitomercurate complex, which resists oxidation by the oxygen in the air, is formed. Once formed, this complex is stable to strong oxidants such as ozone and oxides of nitrogen and therefore, the absorber solution may be stored for some time prior to analysis. The complex is made to react with pararosaniline and formaldehyde to form the intensely colored pararosaniline methylsulphonic acid. The absorbance of the solution is measured by means of a suitable spectrophotometer.

Concentration of sulphur dioxide in the range of 25-1050 µg/m<sup>3</sup> can be measured under the conditions given one can measure concentration below 25 µg/m<sup>3</sup> by sampling larger volumes of air, but only if, the absorber efficiency of the particular system is first determined and found to be satisfactory. Higher concentration can be analyzed by using smaller gas samples of a suitable aliquot of the collected sampler. Beer's law is followed through the working range from 0.03 to 1.0 absorbance unit. This corresponds to 0.8-27 µg of sulfite ion in 25 ml of final solution calculated as sulphur dioxide. The lower limit of detection of sulphur dioxide in 10 ml absorbing reagent is 0.75 µg based on twice the standard deviation, which represent a concentration of 25 µg/m<sup>3</sup> in an air sample of 30 litres.

### **4.0 SCOPE**

This method is applicable for the measurement of concentration of sulphur dioxide present in ambient air.

### **5.0 INTERFERENCES**

The effects of the principal known interferences have been minimized or eliminated. Interferences by oxides of nitrogen are eliminated by sulphamic acid. Ozone is made to decompose by allowing the solution to stand for some time

prior to analysis. The interference of trace metals may be eliminated by the addition of ethylenediamine tetra acetic acid (EDTA) to the absorbing solution prior to sampling. At least 60 µg iron (III), 10 µg manganese (II), and 10 µg chromium (III) in 10 ml absorbing reagent can be tolerated in the procedure. No significant interference was found from 10 µg copper (II) and 22 µg vanadium (V). Ammonium, sulphide, and aldehydes do not interfere.

## **6.0 APPARATUS**

### **6.1 Sampling**

**6.1.1 Absorber** - An all-glass midget impinger, as shown in **Figure-1**, is recommended for 30 minutes, 1 hour and 4 hours samples. For 24 hours sampling, assemble an absorber from the following parts.

#### **6.1.2 Polypropylene Two-Port Tube Closures**

**6.1.3 Glass Impingers** - Tubing, 6 mm OD and 15 cm long. One end is drawn to small diameter so that a No.79 jeweller's drill bit will pass through, but a No.78 jeweller's bit will not. The other end is fire polished.

**6.1.4 Polypropylene Tubes** - Tubes 164 by 32 mm, 'Nalgene' or equivalent.

**6.1.5 Pump** - Capable of maintaining an air pressure differential greater than 0.7 atm at the desired flow rate.

**6.1.6 Air Flowmeter or Critical Orifice** - A calibrated rotameter or critical orifice capable of measuring air flow within 2%. For 30 minutes sampling, a 22 gauge hypodermic needle 2.5 cm long may be used as a critical orifice to give a flow of about 1 litre/minute. For 1 hour sampling, a 23 gauge hypodermic needle 1.6 cm long may be used to give a flow of about 0.2 litre/minute. Use a membrane filter to protect the orifice (**Figure 2**).

### **6.2 Analysis**

A spectrophotometer suitable for measurement of absorbance at 560 nm with an effective spectral band width of less than 15 nm is required. Reagent blank problems may occur with spectrophotometer having greater spectral band widths.

**FIG. 1.0 SO<sub>2</sub> SAMPLING TRAIN**

**FIG. 2.0 CENTRAL ORIFICE FLOW CONTROL**



The wavelength calibration of the instrument should be verified. If, transmittance is measured, this can be converted to absorbance by the formula :

$$A = 2 - \log_{10} T$$

## 7.0 REAGENTS

### 7.1 Sampling

**7.1.1 Water** - High quality water must be used. It must be free from oxidants, particularly chlorine, which may not be removed by distillation. This criterion must be observed whether water is prepared by distilling or deionizing or by using a combination of both techniques.

**7.1.2 Absorbing Reagents, 0.04 M Potassium Tetrachloro mercurate (TCM)** - Dissolve 10.86 g, mercuric chloride, 0.066 g EDTA, and 6.0 g potassium chloride or sodium chloride 4.68 gm in water and bring to the mark in a 1 litre volumetric flask. CAUTION : HIGHLY POISONOUS IF SPILLED ON SKIN, FLUSH OFF WITH WATER IMMEDIATELY. The pH of this reagent should be approximately 4.0 but, it has been shown that there is no appreciable difference in collection efficiency over the range of pH 5 to pH 3. The absorbing reagent is normally stable for six months. If, a precipitate forms, discard the reagent after recovering the mercury.

### 7.2 Analysis

**7.2.1 Sulphamic Acid (0.6%)** - Dissolve 0.6 g sulphamic acid in 100 ml distilled water. Prepare fresh daily.

**7.2.2 Formaldehyde (0.2%)** - Dilute 5 ml formaldehyde solution (36-38%) to 1 litre with distilled water. Prepare fresh daily.

**7.2.3 Stock Iodine Solution (0.1 N)** - Place 12.7 g iodine in a 250 ml beaker, add 40 g potassium iodide and 25 ml water. Stir until all is dissolved, then dilute to 1 litre with distilled water.

**7.2.4 Iodine Solution (0.01 N)** - Prepare approximately 0.01 N iodine solution by diluting 50 ml of stock solution to 500 ml with distilled water.

**7.2.5 Starch Indicator Solution** - Triturate 0.4 gm soluble starch and 0.002 g mercuric iodide preservative with a little water and add the paste slowly to 200 ml boiling water. Continue boiling until the solution is clear, cool, and transfer to a glass-stoppered bottle.

**7.2.6 Stock Sodium Thiosulfate Solution (0.1 N)** - Prepare a stock solution by placing 25 g sodium thiosulfate pentahydrate in a beaker, add 0.1 g sodium carbonate and dissolve using boiled, cooled distilled water making the solution

up to a final volume of 1 litre. Allow the solution to stand one day before standardizing.

To standardize, accurately weigh to the nearest 0.1 mg, 1.5 g primary standard potassium iodate dried at 180°C, dissolve, and dilute to volume in a 500 ml volumetric flask. Into a 500 ml Iodine flask, transfer 50 ml of iodate solution by pipette. Add 2 g potassium iodide and 10 ml of N hydrochloric acid and stopper the flask. After 5 min, titrate with stock thiosulfate solution to a pale yellow. Add 5 ml starch indicator solution and continue the titration until the blue color disappears. Calculate the normality of the stock solution.

**7.2.7 Sodium Thiosulphate Titrant (0.01 N)** - Dilute 100 ml of the stock thiosulfate solution to 1 litre with freshly boiled and cooled distilled water.

**7.2.8 Standardized Sulphite Solution for Preparation of Working Sulphite-TCM Solution** - Dissolve 0.30 g sodium metabisulphite ( $\text{Na}_2\text{S}_2\text{O}_5$ ) or 0.40 g sodium sulphite ( $\text{Na}_2\text{SO}_3$ ) in 500 ml of recently boiled, cooled, distilled water. Sulphite solution is unstable; it is, therefore, important to use water of the highest purity to minimize this instability. This solution contains the equivalent of 320-400  $\mu\text{g}/\text{ml}$  of  $\text{SO}_2$ . The actual concentration of the solution is determined by adding excess iodine and back-titrating with standard sodium thiosulfate solution. To back-titrate, measure, by pipette, 50 ml of the 0.01 N iodine solution into each of two 500 ml iodine flasks A and B. To flask A (blank) add 25 ml distilled water and into flask B (sample) measure 25 ml sulphite solution by pipette. Stopper the flasks and allow to react for 5 minutes. Prepare the working sulphite-TCM solution (section 7.2.9) at the same time iodine solution is added to the flasks. By means of a burette containing standardized 0.01 N thiosulfate, titrate each flask in turn to a pale yellow. Then add 5 ml starch solution and continue the titration until the blue color disappears.

**7.2.9 Working Sulphite-TCM Solution** - Measure 2 ml of the standard solution into a 100 ml volumetric flask by pipette and bring to mark with 0.04 M TCM. Calculate the concentration of sulphur dioxide in the working solution in micrograms of sulphur dioxide per milliliter. This solution is stable for 30 days if kept in the refrigerator at 5°C. If not kept at 5°C, prepare fresh daily.

**7.2.10 Purified Pararosaniline Stock Solution (0.2% Nominal)**

**7.2.10.1 Dye Specifications** - The pararosaniline dye must meet the following specifications :

- (i) The dye must have a wavelength of maximum absorbance at 540 nm when assayed in a buffered solution of 0.1 M sodium acetate - acetic acid.

- (ii) The absorbance of the reagent blank, which is temperature sensitive to the extent of 0.015 absorbance unit/°C, should not exceed 0.170 absorbance unit at 22°C with a 1 cm optical path length, when the blank is prepared according to the prescribed analytical procedure and to the specified concentration of the dye.
- (iii) The calibration curve, section 8.5.2 should have a slope of  $0.030 \pm 0.002$  absorbance unit/ $\mu\text{g SO}_2$  at this path length when the dye is pure and the sulphite solution is properly standardized.

**7.2.10.2 Pararosaniline Stock Solution** – Dissolve 0.5 gm of specially purified Para rosaniline (PRA) in 100 ml distilled water. Keep it for 2 days and filter the solution. The solution is stable for 3 months if stored in a refrigerator.

**7.2.10.3 Pararosaniline Working Solution** - 10 ml of stock PRA is taken in a 250 ml volumetric flask. Add 15 ml conc. HCL and make up to volume with distilled water.

## **8.0 PROCEDURE**

### **8.1 Sampling and Analysis**

**8.1.1 Sampling** - Procedures are described for short-term (30 minutes, 1 hour, 4 hours long-term (24 hours) sampling. One can select different combinations of sampling rate and time to meet special needs. Sample volumes should be adjusted, so that linearity is maintained between absorbance and concentration over the range in question.

**8.1.2 30 Minutes, 1 Hour and 4 Hours Sampling** - Insert a midget impinger into the sampling system (**Figure 1**). Add 10 ml TCM solution to the impinger (30 ml TCM solution for 4 hours sampling). Collect sample at 1 litre/ minute for 30 minutes, 1 hour or 4 hours using either a rotameter, as shown in **Figure 1**, or a critical orifice, as shown in **Figure 2**, to control flow. Shield the absorbing reagent from direct sunlight during and after sampling by covering the impinger with aluminum foil to prevent deterioration. Determine the volume of air sampled by multiplying the flow rate by the time in minutes and record the atmospheric pressure and temperature. Remove and stopper the impinger. If, the sample must be stored for more than a day before analysis, keep it at 5°C in a refrigerator; see section 10.1 during hot weather, sampling is not recommended unless it is possible to refrigerate the samples as taken.

**8.1.3 24 Hours Sampling** - Place 50 ml TCM solution in a large absorber and collect the sample at 0.2 litre/minute for 24 hours. Make sure no entrainment of solution

results with the impinger. During collection and storage protect from direct sunlight. Determine the total air volume by multiplying the air flow rate by the time in minutes. The correction of 24 hours measurements for temperature and pressure may be difficult and is not ordinarily done. However, the accuracy of the measurement will be improved if meaningful corrections can be applied if storage is necessary; refrigerate at 5°C; see section 10.1. During hot weather, sampling is not recommended unless it is possible to refrigerate the samples as taken.

**8.1.4 Sample Preparation** - After collection, if a precipitate is observed in the sample, remove it by centrifugation.

**8.1.5 30 Minutes, 1 Hour and 4 Hours Samples** - Transfer the sample quantitatively to a 25 ml volumetric flask using about 5 ml distilled water for rinsing. Delay analyses for 20 minutes to allow any ozone to decompose.

**8.1.6 24 Hours Sample** - Make-up the entire sample to 50 ml with absorbing solution. Measure 5 ml of the sample into a 25 ml volumetric flask by pipette for chemical analysis. Bring volume to 10 ml with absorbing reagent. Delay analysis for 20 minutes to allow any ozone to decompose.

## **8.2 Sample Preservation**

After sample collection, the solutions must be stored at 5°C in a refrigerator. At 22°C losses of sulphur dioxide occur at the rate of 1% per day. When samples are stored at 5°C for 30 days, no detectable losses of sulphur dioxide occur. The presence of EDTA enhances the stability of sulphur dioxide in solution, and the rate of decay is independent of the concentration of sulphur dioxide.

## **8.3 Determination**

For each set of determinations prepare a reagent blank by adding 10 ml of unexposed TCM solution to a 25 ml volumetric flask. Prepare a control solution by measuring 2 ml of working sulphite-TCM solution and 8 ml TCM solution into a 25 ml volumetric flask by pipette. To each flask containing either sample, control solution, or reagent blank, add 1 ml 0.6% sulphamic acid and allow to react 10 minutes to destroy the nitrite resulting from oxides of nitrogen. Measure by pipette and add 2 ml of 0.2% formaldehyde solution and 2 ml pararosaniline solution. Start a laboratory timer that has been set for 30 minutes. Bring all flasks to volume with freshly boiled and cooled distilled water and mix thoroughly. After 30 minutes and before 60 minutes, determine the absorbance of the sample, A, reagent blank, A<sub>o</sub>, and the control solution at 560 nm using cells with a 1 cm path length. Use distilled water; not the reagent blank, as the optical reference. This is important because of the color sensitivity of the reagent blank to temperature changes which may be induced in the cell compartment of a spectrophotometer. Do not allow the colored solution to stand in the absorbance cells, because a film of dye may be deposited. Clean cells with alcohol and clean

pipe cleaner after use. If, the temperature of the determinations does not differ by more than 2°C from the calibration temperature, the reagent blank should be within 0.03 absorbance unit of the y-intercept of the calibration curve (section 8.5.2). If, the reagent blank differs by more than 0.03 absorbance unit that found in the calibration curve, prepare a new curve.

#### **8.4 Absorbance Range**

If, the absorbance of the sample solution lies between 1.0 and 2.0, the sample can be diluted 1:1 with a portion of the reagent blank and read within a few minutes. Solutions with higher absorbance can be diluted up to six fold with the reagent blank in order to obtain on-scale readings within 10% of the true absorbance value.

#### **8.5 Calibration and Efficiencies**

**8.5.1 Flowmeter and Hypodermic Needle** - Calibrate flowmeter and hypodermic needle (9) against a calibrated wet test meter.

**8.5.2 Calibration Curve - Procedure with Sulphite Solution** - Measure by pipette graduated amounts of the working sulphite-TCM solution (Section 7.2.9) (such as 0, 0.5, 1, 2, 3 and 4 ml) into a series of 25 ml volumetric flasks. Add sufficient TCM solution to each flask to bring the volume to approximately 10 ml. Then add the remaining reagents as described in section 8.3. For maximum precision use a constant-temperature bath. The temperature of calibration must be maintained within  $\pm 1^\circ\text{C}$  and within the range of 20-30°C. The temperature of calibration must be maintained within two degrees. Plot the absorbance against the total concentration in micrograms sulphur dioxide for the corresponding solution. The total micrograms sulphur dioxide in solution equals the concentration of the standard (section 7.2.9) in micrograms sulphur dioxide per milliliter times the milliliter of sulphite solution added ( $\mu\text{g SO}_2 = \mu\text{g/ml/SO}_2 \times \text{ml added}$ ). A linear relationship should be obtained, and the Y-intercept should be within 0.03 absorbance unit of the zero standard absorbance. For maximum precision determine the line of best fit using regression analysis by the method of least squares. Determine the slope of the line of best fit, calculate its reciprocal, and denote as B, the calibration factor. See section 7.2.10.1 for specifications on the slope of the calibration curve. This calibration factor can be used for calculating results provided there are no radical changes in temperature or pH. At least one control sample containing a known concentration of SO<sub>2</sub> for each series of determinations is recommended to ensure the reliability of this factor.

**8.5.3 Sampling Efficiency** - Collection efficiency is generally above 98%; efficiency may fall off, however, at concentrations below 25  $\mu\text{g/m}^3$ .

## 9.0 CALCULATION

### 9.1 Normality of Thiosulfate Solution (Section 7.2.6)

The normality of this solution. N, is calculated as follows :

$$N = \frac{W \times 10^3 \times 0.1}{V \times 35.67}$$

**Where :**

- V - Volume thiosulfate used, ml
- W - Weight of potassium iodate, g
- 35.67 - Equivalent weight of potassium iodate

### 9.2 Concentration of Sulphite Solution

The amount of sulphur dioxide per milliliter in the standard solution, is calculated as follows :

$$C = \frac{(V_1 - V_2) \times N \times K}{V}$$

**Where :**

- C - SO<sub>2</sub> concentration in µg/ml
- V<sub>1</sub> - Volume of thiosulfate for blank, ml
- V<sub>2</sub> - Volume of thiosulfate for sample, ml
- N - Normality of thiosulfate
- K - 32000 (Milliequivalent weight SO<sub>2</sub>/µg)
- V - Volume of standard sulphite solution, ml

### 9.3 Conversion of Volume

Convert the volume of air sampled to the volume at the reference conditions of 25°C and 760 mm :

$$V_r = V \times \frac{P}{760} \times \frac{298}{t + 273}$$

**Where :**

- V<sub>r</sub> - Volume of air at 25°C and 760 mm Hg, litres
- V - Volume of air sampled, litres
- P - Barometric pressure, mm Hg
- t - Temperature of air sampled, °C

### 9.4 Sulphur Dioxide Concentration at the Reference Conditions

When sulphite solutions are used to prepare calibration curves, compute the concentration of sulphur dioxide, C, in micrograms per cubic metre, in the sample as follows :

$$C = \frac{(A - A_o) (10^3) (B)}{V_r} \times D$$

**Where :**

- A - Sample absorbance
- A<sub>o</sub> - Reagent blank absorbance
- 10<sup>3</sup> - Conversion of litres to cubic metres
- V<sub>r</sub> - Volume of air corrected to 25°C and 760 mm Hg, litres
- B - Calibration factor, µg/absorbance unit
- D - Dilution factor

**9.5 The Concentration of SO<sub>2</sub> in µg/m<sup>3</sup> in the sample is calculated as follows:**

$$C (\text{SO}_2 \mu\text{g}/\text{m}^3) = \frac{(A - A_o) \times 10^3 \times B}{V}$$

**Where :**

- A - Sample absorbance
- A<sub>o</sub> - Reagent blank absorbance
- 10<sup>3</sup> - Conversion litres to cubic meters
- B - Calibration factor, µg/absorbance
- V - Volume of air sampled in liters

**9.6 Conversion of Micrograms per Cubic Metre to Parts per Million**

If desired, the concentration of sulphur dioxide may be calculated as parts per million of sulphur dioxide at reference conditions as follows :

$$\text{ppm SO}_2 = \mu\text{g SO}_2/\text{m}^3 \times 3.82 \times 10^{-4}$$

**9.7 Precision and Accuracy**

Relative standard deviation at the 95% level is 4.6% for the analytical procedure using standard samples.

**9.0 REFERENCES**

1. Indian Standard IS :5182 (Part 2), 2001' Methods for Measurement of Air Pollution Part 2 Sulphur Dioxide.

## 6. CONTINUOUS MEASUREMENT OF SULPHUR DIOXIDE - ULTRAVIOLET FLUORESCENCE METHOD

### 1.0 TITLE

Method for continuous measurement of Sulphur Dioxide - Ultraviolet Fluorescence method.

### 2.0 PURPOSE

The purpose is to lay down a uniform and reliable method for measurement of sulphur dioxide in ambient air.

### 3.0 PRINCIPLE

The UV fluorescence method is based on the fluorescence emission of light by SO<sub>2</sub> molecules previously excited by UV radiation.

The first reaction step is :

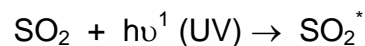

Then in the second step, the excited SO<sub>2</sub><sup>\*</sup> molecule returns to the original ground state, emitting an energy hν<sup>1</sup> according to the reaction :

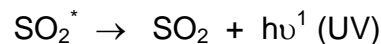

The intensity of the fluorescent radiation is proportional to the number of SO<sub>2</sub> molecules in the detection volume and is therefore proportional to the concentration of SO<sub>2</sub>.

Therefore :

$$F = k [\text{SO}_2]$$

**where :**

F = is the intensity of fluorescence radiation;

k = is the factor of proportionality;

[SO<sub>2</sub>] = concentration of SO<sub>2</sub>

The air sample flows into the inlet of the analyser where it is scrubbed to remove any interference by aromatic hydrocarbons that may be present. A hydrocarbon scrubber device usually accomplishes this.



Then the air sample flows into a reaction chamber, where it is irradiated by UV radiation with a wavelength range of (200-220) nm.

The UV fluorescence light, in the wavelength range of (240-420) nm, is optically filtered and then converted to an electrical signal by a UV detector, for example, a photomultiplier tube.

The response of the analyser is proportional to the number of SO<sub>2</sub> molecules in the reaction chamber. Therefore, temperature and pressure either have to be kept constant, or if variation of these parameters is expected, the measured values have to be corrected.

For this UV fluorescence method to yield accurate concentration measurements, it must be calibrated against some primary standard (see clause 5.4).

#### **4.0 SCOPE**

This method is applicable for measurement of sulphur dioxide in ambient air.

#### **5.0 REAGENTS AND MATERIALS**

##### **5.1 Sampling Line**

The sampling line and its residence time shall be as short as practical. This line shall be chemically inert to SO<sub>2</sub>, such as fluorocarbon polymer or glass. If any doubt exists as to the inertness of the sampling line, calibration gases must be used to test the complete sampling train.

**Note :** In case water is expected to condense in the sampling line (when humid ambient air is drawn into a cool measurement environment), auxiliary heating of the sampling line will be necessary.

##### **5.2 Sample Inlet Particulate Matter Filter**

The inlet particulate matter filter shall remove particles, which could interfere with the correct operation of the analyser. It shall not remove any SO<sub>2</sub> and consequently the filter and its support shall be made from inert material, such as fluorocarbon polymer.

**Note 1 :** If possible, install the filter at the inlet of the sampling line leading to the instrument in order to prevent contamination of the sampling component by ambient particulate matter.

**Note 2 :** A 5 micrometre pore size fluorocarbon polymer filter is effective. Replacing filters loaded with particulate matter monthly is generally

sufficient. Depending on the concentration of suspended particulate matter in ambient air, the filter can be replaced more frequently.

### 5.3 Zero Air

Zero air used in the calibration of the analyser should not contain a concentration of SO<sub>2</sub> detectable by the analyser under calibration. The concentration of O<sub>2</sub> in the zero air shall be within +/-2% of the normal composition of air (20.9%).

### 5.4 SO<sub>2</sub> Calibration Gas Mixtures

**5.4.1 Primary Calibration Method** - Several equivalent methods for primary calibration can be used :

- static volumetric dilution
- permeation tube sources
- TCM - Tetrachloromercurate method
- gravimetric preparation of gas mixture in combination with various dilution systems

Several methods for generating SO<sub>2</sub> calibration gas standard mixtures are proposed below. Whatever method is chosen, it is recommended that it be compared periodically against another independent traceable calibration method. The range of SO<sub>2</sub> calibration concentrations chosen, shall be between 10% to 90% of the SO<sub>2</sub> concentration range in use.

**5.4.2 Transfer Standard Calibration Method** - Other methods to prepare calibration standard gases may also be used, if they are compared to one or more of the above mentioned methods. Even though any of the primary calibration methods may be used as transfer standards, in practice, it is easier to use a laboratory calibrated permeation source or cylinder of SO<sub>2</sub>. The latter may be used either directly (with cylinders containing 0.1 mg/m<sup>3</sup> to 10.0 mg/m<sup>3</sup> (0.03 ppm to 5 ppm) of SO<sub>2</sub> in air), or with appropriate quantitative dilution (using cylinders containing ten to several hundred µg/m<sup>3</sup> of SO<sub>2</sub> in air).

**Note** : Gas cylinders shall be made of an inert material or have been passivated to ensure stability of +/-3% for the period of use expected. Low concentration cylinder must be checked regularly against primary standards.

**5.4.3 Operational (Field) Span Check** - To aid in the quality control of the routine operation of the analyser on-site, span checks may be performed regularly (e.g. daily or weekly). For example, an internal permeation device may form an

integral part of the apparatus, or an external calibrated cylinder, with appropriate dilution if necessary, may be used.

The described span check system is suitable for quality control in routine operation to verify that the analyser is operating correctly, but may not be suitable for proper calibration as described in 5.5.1. The span check system should regularly be compared to a laboratory-based calibration system as described in 5.4.1.

## **6.0 APPARATUS**

### **6.1 Description**

**Figure 1** shows the schematic of an analyser for measuring SO<sub>2</sub> by UV fluorescence. The main components are described below.

### **6.2 Selective Traps for Interfering Agents**

One or more selective traps should be used before the reaction chamber to remove interfering gases such as aromatic hydrocarbons. These selective traps shall not retain any SO<sub>2</sub> and shall be changed in accordance with manufacturers instruction manual.

If high concentrations of H<sub>2</sub>S are expected in the ambient air, a selective scrubber should be used.

### **6.3 Optical Assembly and Fluorescence Cell**

The UV lamp emission may be pulsed electronically or mechanically for synchronous detection and amplification of the signal. The lamp shall have a stabilised power supply to ensure a stable emission of light. An optical filter is used to restrict the wavelengths to a range, which allows excitation of the SO<sub>2</sub> molecule and yet minimise the interference of water vapour, aromatic hydrocarbons or nitric oxide.

The UV detector, for example, the photomultiplier tube, detects the fluorescence light emitted by the SO<sub>2</sub> molecules in the reaction chamber. A selective optical filter placed in front of the UV detector, reduces the signal due to scattering of the incident light. The reaction chamber shall be made of material inert to SO<sub>2</sub> and UV radiation. The cell should be heated above the dew point to avoid water condensation, and temperature fluctuations. The optical trap of the chamber prevents reflection of the exciting UV radiation. The optical assembly should be placed in a heated enclosure.

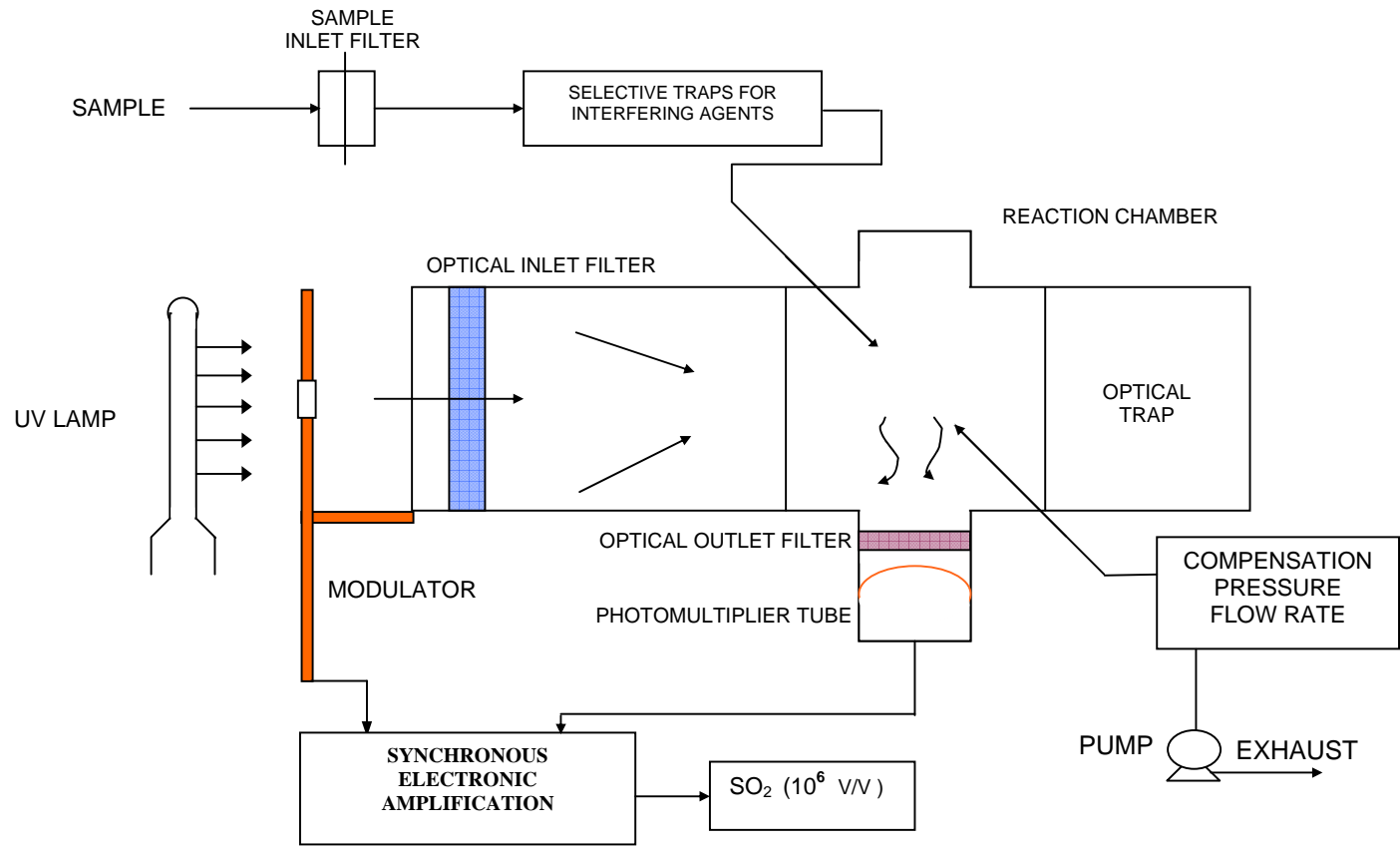

**FIG : 1 SCHEMATIC DIAGRAM OF A UV FLUORESCENCE SO<sub>2</sub> ANALYSER**

## **6.4 Pressure Regulator**

The output signal of the analyser depends on the pressure in the reaction chamber and is therefore proportional to the density of SO<sub>2</sub> (number of SO<sub>2</sub> molecules) present in the reaction chamber. Variations of internal pressure shall be measured and the signal corrected or controlled by means of a regulator. The signal may have to be corrected also for external pressure and temperature fluctuations. Significant pressure corrections are due to synoptic meteorological changes (up to + 3%) or by the attitude of the measurement site (about 10% decrease in pressure for a 800 m rise in attitude).

**Note :** One of the main causes of a reduced pressure in the reaction chamber, is a pressure drop in the sample line.

## **6.5 Flow Rate Controller and Indicator**

It is recommended that the flow rate be kept constant by means of a flow controller. A flow rate indicator should be included in the instrument.

## **6.6 Air Pump**

A pump, which draws air through the analyser, is placed at the end of the sample flow path. If the use of UV lamp produces ozone, it is recommended to vent this ozone outside the room and far away from the sampling inlet, or a suitable charcoal filter may trap it.

## **7.0 PROCEDURE**

### **7.1 Operation of the Ambient SO<sub>2</sub> Analyser**

Install the instrument in a suitable location. Follow the manufacturer's operating instructions to set the various parameters correctly, including UV source lamp intensity, sample flow rate, and (if applicable) the activation of the electronic temperature/pressure compensation. Check to ensure that the manufacturer's performance specifications are met or exceeded. If necessary, the location shall also be temperature controlled so as to minimise the effect of the temperature dependence of the instrument.

Sample air through the instrument and record the SO<sub>2</sub> concentration by means of a suitable recording device (for example, chart recorder, electronic data acquisition system, etc.). During continuous operation of the instrument, checks of the instrument zero, span, and operational parameters shall be made at least one a week. In order to ensure optimum analyser performance, follow the maintenance schedule as detailed in the manufacturers instruction manual. It is recommended that the analyser be fully serviced either every 6 month or

annually as appropriate based on the performance of the analyser. A full calibration of the instrument should be carried out before and after this service.

## **7.2 Calibration of the Ambient SO<sub>2</sub> Analyser**

**7.2.1 Principle** - During this procedure, the ambient SO<sub>2</sub> analyser shall be operated at its normal flow rate and temperature. The calibration includes measurements of zero air, span gas (see 5.3), and at least five SO<sub>2</sub> concentrations (using a primary calibration gas standard described in 5.4.1) which shall be spaced to cover the ambient range.

For all calibrations, flow of calibration gases to the manifold shall exceed, by at least 20%, the total flow required by the instrument attached to the manifold, with the excess appropriately vented at atmospheric pressure. A schematic diagram of a calibration system is shown in **Figure 2**.

Alternatively, a transfer standard calibration method can be calibrated against the SO<sub>2</sub> primary standard and then used to calibrate the ambient analyser at the sampling location.

**7.2.2 Calibration Procedure** - Carry out the following steps in the calibration procedure:

- (a) Assemble the apparatus as shown in **Figure 2**; for SO<sub>2</sub> analysers with automatic electronic temperature and pressure compensation, ensure that this circuit has been activated to yield corrected output values; for analysers without these compensations, measure and record the temperature of the reaction chamber and its internal pressure;
- (b) Introduce zero air into the manifold; if necessary, change the zero control setting of the SO<sub>2</sub> analyser to indicate an output reading close or equal to zero;
- (c) Record the output values of the SO<sub>2</sub> analyser;
- (d) Adjust the calibration source to produce the SO<sub>2</sub> concentration required for the span control setting; this concentration can be 50% of the analyser full scale, or of the expected SO<sub>2</sub> analyser to indicate an output reading close or equal to the concentration produced.
- (e) Record the output values of the SO<sub>2</sub> analyser;
- (f) Repeat step (b); if the span and zero settings are not independent, then the foregoing sequence of step (b) to (e) must be repeated.

**FIG. 2 SCHEMATIC DIAGRAM OF A CALIBRATION SYSTEM**

- (g) Repeat step (d) and (e) with another five SO<sub>2</sub> concentration without changing the span setting;
- (h) Plot the SO<sub>2</sub> analyser output values obtained in step (f) and (g) versus the concentration used;
- (i) Determine the calibration line of the analyser by means of a single linear regression.

**Note :** Optionally, the procedure described above can be repeated if the determinations of precision and accuracy are required.

**7.2.3 Field Calibration Procedure with a Transfer Standard** - A two-point calibration of the analyser with a transfer standard calibrated previously against a reference calibration system is acceptable in field conditions. In this case, follow the step (b) to (e) of clause 7.2.2.

## 8.0 EXPRESSION OF RESULTS

Record the output signal for the air sample to be measured. Determine the corresponding concentration by using the appropriate calibration function obtained in clause 7.2.2.

Report the result, µg/m<sup>3</sup> or mg/m<sup>3</sup>, or the equivalent volume fractions ppb (v/v) or ppm (v/v).

The equation to be used for converting ppm (v/v) into mg/m<sup>3</sup> is as follows :

$$C_1 = \frac{C_2 \times 64 \times 298 \times P}{24.459 \times T \times 101.3}$$

### Where :

- C<sub>1</sub> = is the concentration of SO<sub>2</sub>, expressed in mg/m<sup>3</sup>
- C<sub>2</sub> = is the concentration of SO<sub>2</sub>, expressed in ppm (v/v)
- 64 = is the molar mass of SO<sub>2</sub>, expressed in g/mol
- 298 = is the reference absolute temperature, expressed in K
- P = is the measured gas pressure, expressed in hPa
- 24.459 = is the volume of 1 mol, expressed in L, at 298 K and 1013 hPa
- T = is the measured temperature, expressed in K
- 101.3 = is the reference gas pressure, expressed in hPa

## 9.0 REFERENCE

1. ISO 10498.2. Ambient Air - Determination of Sulphur Dioxide - Ultraviolet Fluorescence method.



## **7. CONTINUOUS MEASUREMENT OF CARBON MONOXIDE - NON-DISPERSIVE INFRARED SPECTROMETRY METHOD**

### **1.0 TITLE**

Method for continuous measurement of Carbon Monoxide - Non-Dispersive Infrared Spectrometry method.

### **2.0 PURPOSE**

The purpose is to lay down a uniform and reliable method for measurement of carbon monoxide in ambient air.

### **3.0 PRINCIPLE**

An atmospheric sample is introduced into a sample conditioning system and then into a non-dispersive infrared spectrometer (NDIR).

The spectrometer measures the absorption by CO at 4.7  $\mu\text{m}$  [1] using two parallel infrared beams through a sample cell, a reference cell and a selective detector. The detector signal is led to an amplifier control section and the analyser output measured on a meter and recording system.

Some instruments use gas filter correlation to compare the IR absorption spectrum between the measured gas and other gases present in the sample, in a single sample cell. These instruments utilize a highly concentrated sample of CO as a filter for the IR transmitted through the sample cell, to yield a beam that cannot be further attenuated by the CO in the sample and thus acts as a reference beam. The broadband radiation that passes through the sample cell and the CO filter is filtered again by a narrow-bandpass filter that allows only the CO-sensitive portion of the band to pass to the detector. The removal of wavelength sensitive to other gases reduces interferences.

### **4.0 SCOPE**

This method is applicable for measurement of carbon monoxide in ambient air. The method has a lower limit of detection of about 0.006  $\text{mg}/\text{m}^3$  (0.05 ppm volume fraction) carbon monoxide in air.

## 5.0 INTERFERENCES

### 5.1 General

The degree of interference, which occurs varies among individual NDIR instruments. Consult the manufacturer's specifications for the particular analyser to determine whether interferences render the instrument unsuitable for the proposed use.

### 5.2 Water Vapour

The primary interferant is water vapour, and is a function of the water vapour content on the sample gas. With no correction, the error may be as high as 11 mg/m<sup>3</sup> (10 ppm volume fraction) [5].

Water vapour interference can be minimized by using one or more of the following procedures :

- (a) Passing the air sample through a semi-permeable membrane or a similar drying agent;
- (b) Maintaining a constant humidity in the sample and calibration gases by refrigeration;
- (c) Saturating the air sample and calibration gases to maintain constant humidity;
- (d) Using narrow-band optical filters in combination with some of the above measures;
- (e) Making a volume correction, if the sample is dried or humidified.

**Note** : Gas-correlation spectrometers facilitate rejection of interference by water vapour, carbon dioxide and organic compounds, therefore, use of a narrow-band-pass filter ensures that only the CO-sensitive IR wavelengths are measured.

### 5.3 Carbon Dioxide

Interference may be caused by carbon dioxide (CO<sub>2</sub>). The effect of CO<sub>2</sub> interference at concentrations normally present in ambient air is minimal; that is, 600 mg/m<sup>3</sup> (340 ppm volume fraction) of CO<sub>2</sub> may give a response equivalent to 0.2 mg/m<sup>3</sup> (0.2 ppm volume fraction) [3]. If necessary, CO<sub>2</sub> may be scrubbed with soda lime.

### 5.4 Hydrocarbons

Hydrocarbons at concentrations normally found in the ambient air do not ordinarily interfere; that is, 325 mg/m<sup>3</sup> (500 ppm volume fraction) of methane may give a response equivalent to 0.6 mg/m<sup>3</sup> (0.5 ppm volume fraction) [3].

## 6.0 APPARATUS

### 6.1 NDIR Analyser - for analysis of carbon monoxide in air.

The analyser should be complete with analyser section, sample pump, amplifier/control section, meter, and recording system. The NDIR analyser shall meet the performance specifications described in 13.0. See **Figure-1**.

### 6.2 Sample Conditioning System, consisting of flow control valve, rotameter, particulate matter filter, and moisture controller.

### 6.3 Thermometer, capable of measuring atmospheric temperature to $\pm 0.5^{\circ}\text{C}$ .

### 6.4 Barograph or Barometer, capable of measuring atmospheric pressure to $\pm 0.6$ kPa.

### 6.5 Calibration Equipment - The two acceptable method for dynamic multipoint calibration of CO analysers are :

- (a) the use of individual certified standard cylinders of CO for each concentration needed;
- (b) the use of one certified standard cylinder of CO, diluted as necessary with zero-air, to obtain the various calibration concentration needed.

Both methods require the following equipment.

#### 6.5.1 **Pressure Regulators for the CO Cylinders** - A two-stage regulator with inlet and delivery pressure gauges will be required for the CO calibration standard cylinder. Procure regulators for each cylinder if individual cylinders are to be used for individual calibration points. Ensure the cylinders have a non-reactive diaphragm and suitable delivery pressure. Consult the supplier from whom the CO cylinders are to be obtained for the correct cylinder fitting size required for the regulator.

#### 6.5.2 **Flow Controller** - The flow controller can be any device (valve) capable of adjusting and regulating the flow from the calibration standard. If the dilution method is to be used for calibration, a second device is required for the zero-air. For dilution, the controllers shall be capable of regulating the flow $\pm 1\%$ .



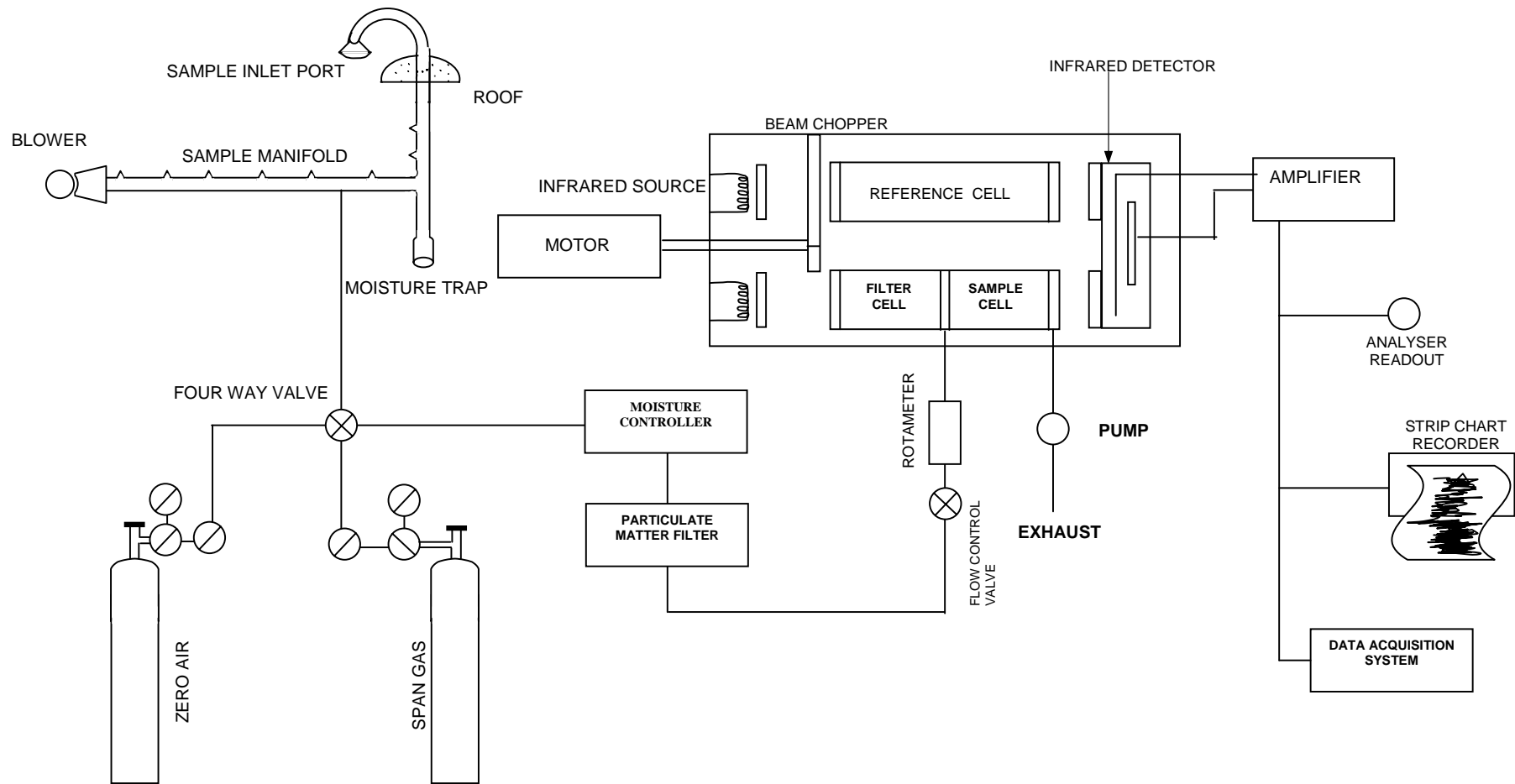

**FIG : 1 TYPICAL CARBON MONOXIDE ANALYSER SYSTEM.**

- 6.5.3 **Flow Meter** - A calibrated flow meter capable of measuring and monitoring the calibration standard flow rate. If, the dilution method is used, a second flow meter is required for the zero-air flow. For dilution, the flow meters shall be capable of measuring the flow with an accuracy  $\pm 2\%$ .
- 6.5.4 **Mixing Chamber (Dynamic Dilution Only)** - A mixing chamber is required only if the calibrator concentrations are generated by dynamic dilution of a CO standard. Design the chamber to provide thorough mixing of CO and zero-air.
- 6.5.5 **Output Manifold** - The output manifold should be of sufficient diameter to ensure an insignificant pressure drop at the analyser connection. The system shall have a vent designated to ensure atmospheric pressure at the manifold and to prevent ambient air from entering the manifold.

## 7.0 REAGENTS AND MATERIALS

- 7.1 **Zero Air** - Use a pressurized cylinder of pure air certified to contain less than  $0.1 \text{ mg/m}^3$  (0.09 ppm volume fraction) of CO. Alternatively, a catalytic oxidizing agent to convert CO to  $\text{CO}_2$  or a palladium filter may be used to obtain zero-air.
- 7.2 **Up-scale Span Gas** - Use a pressurized cylinder containing a span gas mixture consisting of CO in air corresponding to 80% of full scale.
- 7.3 **Calibration Gases** - Use pressurized cylinders containing concentrations of CO in air corresponding to the instrument operating range that is, 10%, 20%, 40% and 80% of full-scale range. They shall be certified to a national standard.

Alternatively, if a dilution calibration method is used, a single pressurized cylinder may be used. This may be in nitrogen if the zero-air dilution ratio is not less than 100:1.

- 7.4 **Calibration Certificate** - Certify the span and calibration gases to  $\pm 2\%$  of the stated value.

## 8.0 PRECAUTIONS

Operate the analyser system in non-explosive areas unless the equipment is explosion-proof.

Follow standard safety practices for the handling and storage of compressed gas cylinders and the installation and use of the analyser.

Do not expose cylinders of compressed gases of direct sunlight or excessive heat.

Maintain the same sample cell flow rate during sampling and calibration. Use the same sample pump.

## **9.0 SAMPLING**

When sampling the outside ambient from an enclosure, utilize a sampling line or probe extending at least 1m from the enclosure, and protected against the entry of precipitation.

Place the analyser in an enclosure with atmospheric control so the temperature remains constant within  $\pm 5^{\circ}\text{C}$ .

Record the temperature and pressure of the atmosphere sample.

## **10.0 CALIBRATION AND STANDARDIZATION**

**10.1 Calibration Procedures** - Calibration procedures shall be in accordance with 14.0.

### **10.2 Frequency of Calibration**

**10.2.1 Multipoint Calibration** - Perform a multipoint calibration (see 14.1) when :

- (a) The analyser is first purchased;
- (b) The analyser has had maintenance that could affect its response characteristics;
- (c) The analyser shows drift in excess of specifications as determined when the zero and span calibration are performed (see 10.2.2).

**10.2.2 Zero and Span Calibration** - Perform zero and span calibrations (see 14.2) before and after each sampling period or, if the analyser is used continuously, daily.

## **11.0 PROCEDURE**

Determine the performance characteristics. Establish calibration, check the analyser system operating parameters, and set the sample flow rate.

When the analyser output has stabilized, take the recorder readout and determine the concentration of CO directly from the calibration curve in milligrams per cubic metre or in ppm volume fraction, depending on the analyser output. See clause 12 to convert ppm volume fraction to milligrams per cubic metre.

Perform the operational checks required in **15.0** daily, or during each sampling period [5].

## 12.0 CALCULATION

To convert ppm volume fraction to milligrams per cubic metre, use the following equation :

$$\rho_1 = \frac{\rho_2 \times m_r \times 298\rho}{24\,450 \times T \times 101.3}$$

**Where :**

$\rho_1$	=	is the CO mass concentration, in milligrams per cubic metre
$\rho_2$	=	is the CO mass concentration, ppm volume fraction
$m_r$	=	is the molar mass of carbon monoxide, (28 g/mol)
298	=	is the standard absolute temperature, in kelvin
$\rho$	=	is the measured gas pressure, in kilopascals
24 450	=	is the molecular volume of 1 mole, in millilitres
T	=	is the measured absolute gas temperature, in kelvin
101.3	=	is the standard gas pressure, in kilopascals

## 13.0 MINIMUM PERFORMANCE SPECIFICATIONS FOR NON-DISPERSIVE INFRARED CARBON MONOXIDE ANALYSER

<b>Range (minimum)</b>	:	0 to 115 mg/m <sup>3</sup> (0 to 100 ppm volume fraction)
<b>Rise time (90%)</b>	:	5 minutes (maximum)
<b>Fall time (90%)</b>	:	5 minutes (maximum)
<b>Zero drift</b>	:	± 1% per day of upper range limit or of applicable range
<b>Span drift</b>	:	± 1% per day and ± 2% per 3 days (maximum)
<b>Precision</b>	:	± 4% (maximum)
<b>Operation period (minimum)</b>	:	3 days
<b>Noise level</b>	:	± 0.5% of full scale or linearly decreased to zero scale
<b>Operating temperature range</b>	:	5°C to 40°C
<b>Operating temperature fluctuation</b>	:	± 5°C
<b>Linearity</b>	:	2% of full scale



## 14.0 CALIBRATION PROCEDURE

### 14.1 Analyser Multipoint Calibration

14.1.1 **Cylinder Pressure Check** - Check the pressure of each calibration gas cylinder. If a cylinder pressure is less than 2 MPa, discard the cylinder.

#### 14.1.2 *Calibration Procedure*

##### 14.1.2.1 *Procedure using dynamic dilution method*

- (a) Assemble a dynamic calibration system such as that shown in **Figure-2**. Introduce the calibration gases, including zero-air, into the sample inlet of the analyser.
- (b) Calibrate the flow meters under the conditions of use against an authoritative standard such as a soap-bubble meter or wet-test meter. Correct the volumetric flow rates to 298 K and 101.3 kPa.
- (c) Select the operating range of the CO analyser to be calibrated.
- (d) Connect the signal output of the CO analyser to the input of the strip chart recorder or other data collection device. Base the adjustments to the analyser on the appropriate strip chart or data device readings. References to analyser responses in the procedure given below refer to recorder or data-device responses.
- (e) Adjust the calibration system to deliver zero-air to the output manifold. The total air flow shall exceed the total demand of the analyser connected to the output manifold, to ensure that no ambient air is pulled into the manifold vent. Allow the analyser to sample zero-air until a stable response is obtained. After the response has stabilized, adjust the analyser zero control. Offset the analyser zero adjustments to + 5% of scale to facilitate observing negative zero drift. Record the stable zero-air response as  $Z_{CO}$ .
- (f) Adjust the zero-air flow and the CO flow from the standard CO cylinder to provide a diluted CO concentration of approximately 80% of the upper range limit (URL) of the operating range of the analysers

**FIG. 2 DILUTION METHODS FOR CALIBRATION**

connected to the output manifold, to ensure that no ambient air is pulled into the manifold vent. Calculate the CO concentrations :

$$[\text{CO}]_{\text{OUT}} = \frac{[\text{CO}]_{\text{STD}} \times \theta_{\text{CO}}}{\theta_{\text{D}} + \theta_{\text{CO}}}$$

**Where :**

$[\text{CO}]_{\text{OUT}}$  = is the diluted CO mass concentration at the output manifold, in milligrams per cubic metre (ppm volume fraction)

$[\text{CO}]_{\text{STD}}$  = is the mass concentration of the undiluted CO standard, in milligrams per cubic metre (ppm volume fraction)

$\theta_{\text{CO}}$  = is the flow rate of the CO standard corrected to 298 K and 101.3 kPa in litres per minute

$\theta_{\text{D}}$  = is the flow rate of the dilution air corrected to 298 K and 101.3 kPa, in litres per minute. Adjustment to zero span.

(g) Sample this CO concentration until a stable response ( $\pm$  of nominal upper range limit) is obtained. Adjust the analyser span control to obtain a recorder response as indicated below :

$$\text{Recorder response (percent scale)} = \left[ \frac{[\text{CO}]_{\text{OUT}}}{\text{URL}} \times 100 \right] + Z_{\text{CO}}$$

**Where :**

URL = is the nominal upper range limit of the analyser's operating range, and

$Z_{\text{CO}}$  = is the analyser response to zero-air, as percent scale

(h) If substantial adjustment to the analyser span control is required, it may be necessary to recheck the zero and span adjustments by repeating step (e) and (f). Record the CO mass concentration and the analyser response.

(i) Generate several additional concentrations (at least three evenly spaced points across the remaining scale are suggested to verify linearity) by decreasing  $\theta_{\text{CO}}$  or increasing  $\theta_{\text{D}}$ . Recheck any calibration point deviating more than  $\pm (1.0 + 0.02 [\text{CO}]_{\text{STD}})$  from the smooth curve. If the recheck gives the same result, reanalyse the

calibration gas. Ensure that the total flow exceeds the analyser total flow demand. For each concentration generated, calculate the exact CO mass concentration using the equation in step (f). Record the concentration and the analyser response for each concentration. Draw a best-fit regression curve passing through the zero and span points. The curve shall be linear.

#### **14.1.2.2 Procedure using multiple cylinders method**

Use the procedure for the dynamic method with following changes.

- (a) Use a multicylinder system such as the typical one shown in **Figure-3**.
- (b) The flow meter need not be accurately calibrated, provided the flow in the output manifold exceeds the analyser flow demand.
- (c) Obtain the various CO calibration concentrations required in 14.1.2.1, step (f) and (g), without dilution, by selecting the appropriate certified standard cylinder.

### **14.2 Zero and Span Calibration Procedures**

Carry out the procedure 14.1.1.

Allow the analyser to sample the 80% span gas until a stable trace is obtained, or for five times the response time, whichever is greater. Mark the reading as "unadjusted span". Do not make any adjustments to zero or span.

Allow the analyser to sample the zero-gas until a stable trace is obtained, or for five times the response time, whichever is greater. Mark the reading as "unadjusted zero".

Adjust the zero control until the trace corresponds to the true zero-gas setting. Mark the trace as "adjusted zero".

Allow the analyser to sample the 80% span gas until a stable trace is obtained, or for five times the response time, whichever is greater.

Adjust the span control until the trace corresponds to the true span gas setting. Mark the trace as "adjusted span".

Resume sampling the ambient air.

**FIG. 3 MULTIPLE CYLINDER CALIBRATION**

## 15.0 OPERATIONAL CHECKS

**15.1 Zero and Span Settings** - If the required zero and span corrections performed in accordance with clause 14.2 are greater than 80% of the range, have the analyser serviced.

**15.2 Sample Flow Rate** - If the sample flow rate has changed by more than  $\pm 20\%$  of the initial value, check the particulate filter for blockage, and the sample pump for proper operation. Check the filter monthly by measuring the flow rate with and without the filter in place. Replace the filter if the drop is more than 5%.

**15.3 Temperature Control** - Check the temperature of the shelter or room in which the analyser is located. If, it has changed by more than  $\pm 5^{\circ}\text{C}$ , have the heating-cooling system serviced.

**15.4 Analog Recording System** - Check the strip chart recorder for the following :

- (a) Chart speed setting
- (b) Gain control setting
- (c) Ink supply
- (d) Paper supply
- (e) Excessive noise
- (f) Proper operation of analyser
- (g) Time-mark, sign and date the record

**15.5 Digital Recorder** - Perform the checks in accordance with the manufacturer's instructions.

## 16.0 REFERENCES

1. Dechant, R.F. and Mueller, P.K., "Performance of Continuous NDIR Carbon Monoxide Analyser", Report No. 57, Air and Industrial Hygiene Laboratory, Department of Public Health, Berkeley, CA, USA, June 1969.
2. Jacobs, M.B., Braverman, M.M. and Hochheiser, S., "Continuous Determination of Carbon Monoxide and Hydrocarbons in Air by a Modified Infrared Spectrometer", J. Air Pollution Control Assoc., 9, 1959, pp. 110-114.
3. Moore, M.A., "Critical Evaluation of the Analysis of Carbon Monoxide with Nondispersive Infrared, NDIR", presented at the Ninth Conference on Methods in Air Pollution and Industrial Hygiene Studies, Pasadena, CA, USA, Feb. 7-9, 1968.
4. McKee, H.C. and Childers, R.E., "Collaborative Study of Reference Method for the Continuous Measurement of Carbon Monoxide in the Atmosphere

(Nondispersive Infrared Spectrometry)", Southwest Research Institute, Contract CP 70-40, SWRI Report 01-2811, San Antonio, TX, USA, May 1972.

5. Smith, F. and Nelson, A.C., "Guidelines for Development of Quality Assurance Programme. Reference Method for Continuous Measurement of CO in the Atmosphere", Environmental Protection Agency Document, EPA-R4-73-028a. Research Triangle Institute Park, NC, USA, 1973.
6. EPA QA Handbook, Vol. 2, EPA-600/4-77-027a, Section 2.6.0, "Reference Method for Determination of Carbon Monoxide in the Atmosphere (Nondispersive Infrared Photometry).

## **8. DETERMINATION OF NITROGEN DIOXIDE IN THE ATMOSPHERE**

### **1.0 TITLE**

Method for determination of Nitrogen Dioxide in the Atmosphere (Sodium Arsenite method).

### **2.0 PURPOSE**

The purpose is to lay down an uniform and reliable method for sampling and analysis of nitrogen dioxide in ambient air.

### **3.0 PRINCIPLE**

3.1 Ambient nitrogen dioxide (NO<sub>2</sub>) is collected by bubbling air through a solution of sodium hydroxide and sodium arsenite. The concentration of nitrite ion (NO<sub>2</sub><sup>-</sup>) produced during sampling is determined colorimetrically by reacting the nitrite ion with phosphoric acid, sulfanilamide, and N-(1-naphthyl)-ethylenediamine dihydrochloride (NEDA) and measuring the absorbance of the highly colored azo-dye at 540 nm.

3.2 The nominal range of the method is 9 to 750 µg NO<sub>2</sub>/m<sup>3</sup> (0.005 to 0.4 ppm)<sup>3</sup>. The range of the analysis is 0.04 to 2.0 µg NO<sub>2</sub>/ml, following Beer's Law throughout this range (0 to 1.0 absorbance units). Under the specified conditions of 50 ml of absorbing reagent, a sampling rate of 200 cm<sup>3</sup>/min for 24 hours, and a sampling efficiency of 0.82, the range of the method is, therefore, 9 to 420 µg/NO<sub>2</sub>/m<sup>3</sup> (0.005 to 0.22 ppm). Nitrogen dioxide concentrations in the range of 420 to 750 µg/m<sup>3</sup> (0.22 to 0.4 ppm) are accurately measured by 1:1 dilution of the collected sample.

3.3 Based on results from a collaborative study, the within laboratory standard deviation is 8 µg/m<sup>3</sup> (0.004 ppm) and the between laboratory standard deviation is 11 µg/m<sup>3</sup> (0.006 ppm) over the range of 50 to 300 µg NO<sub>2</sub>/m<sup>3</sup> (0.027 to 1.16 ppm)<sup>4</sup>.

3.4 Based on results from a collaborative study, the method has an average bias of -3% over the range of 50 to 300 µg NO<sub>2</sub>/m<sup>3</sup> (0.027 to 0.16 ppm)<sup>4</sup>.

### **4.0 SCOPE**

This method is applicable to 24 hours integrated sampling of NO<sub>2</sub> in ambient air.



## 5.0 INTERFERENCES

- 5.1 Nitric oxide (NO) is a positive interferant and carbon dioxide (CO<sub>2</sub>) is a negative interferant. The average error resulting from normal ambient concentrations on NO and CO<sub>2</sub> is small for most monitoring situations and does not necessitate applying a correction to measurements obtained with the method<sup>3</sup>.
- 5.2 Potential interference from sulfur dioxide (SO<sub>2</sub>) is eliminated by converting any SO<sub>2</sub> to sulfate with hydrogen peroxide during analysis<sup>5</sup>.

## 6.0 SAMPLE PRESERVATION

Collected samples are stable for at least six weeks at room temperature. Stored samples should be tightly sealed to prevent absorption of NO<sub>2</sub> from the atmosphere.

## 7.0 APPARATUS

7.1 **Sampling** - A diagram of the sampling system is shown in **Figure 1**.

7.1.1 **Sample Inlet** - Teflon<sup>R</sup> or glass tube with an inverted Teflon<sup>R</sup> or glass funnel at the sampling point to prevent entrance of precipitation.

7.1.2 **Absorber** - Polypropylene tube, 164 mm long x 32 mm diameter, equipped with a polypropylene two-port closure (see **Figure 1**). (Rubber stoppers cause high and variable blank values and should not be used). The closure must be fitted with an 8 mm O.D., 6 mm I.D. glass approximately 152 mm long having the end drawn out to form an orifice with an I.D. of 0.3-0.8 mm. This tube must be positioned to allow a clearance of 5 mm from the orifice to the bottom of the absorber. The closure and ports must be free of leaks.

7.1.3 **Moisture Trap** – Polypropylene or glass tube similar to absorber. The entrance port of the closure is fitted with tubing that extends to the bottom of the trap. The unit is loosely packed with glass wool or silica gel to trap moisture to protect the flow control device. The trap must be repacked with fresh glass wool or silica gel before the start of each sampling period.

7.1.4 **Membrane Filter** - Of 0.8 to 2.0 micron porosity and 3 cm diameter. Be sure the filter does not leak. The filter must be replaced after collecting 10 samples.

7.1.5 **Flow Control Device** - Any device capable of maintaining a constant flow through the sampling solution between 180 and 220 cm<sup>3</sup>/min. A convenient flow control device is a 27 gauge hypodermic needle,<sup>6</sup> 10 mm (3/8 in.) long, used as a critical orifice. (Most 27 gauge needles will give flow rates in this range).

**FIG. 1 SAMPLING SYSTEM**

**7.1.6 Air Pump** - Capable of maintaining a vacuum of at least 0.6 atmosphere (450 torr) across the flow control device. [This value is based on the critical pressure differential, 0.53 atmosphere (400 torr)<sup>6</sup>, plus a safety factor to allow for variations in atmospheric pressure and minor variations in pump performance].

**7.1.7 Flowmeter** - Properly calibrated flowmeter for measuring air flow rates in the range of 150-250 cm<sup>3</sup>/min. The use of a mass flowmeter is particularly convenient since no corrections are required when used under temperature and pressure conditions that differ from the conditions under which it is calibrated (see 10.1).

**7.1.8 Flow Measurement Standard** - Precision wet test meter (1 litre/revolution), bubble flowmeter, or other reliable standard.

## **7.2 Analysis**

**7.2.1 Volumetric Flasks** - 100, 250, 500, 1,000 ml.

**7.2.2 Pipets** - 1, 2, 5, 10, 15, 20, 50 ml volumetric; 2 ml, graduated in 1/10 ml intervals.

**7.2.3 Test Tubes** - Approximately 150 mm long x 20 mm diameter.

**7.2.4 Spectrophotometer** - Capable of measuring absorbance at 540 nm; equipped with 1 cm optical path length cells.

## **8.0 REAGENTS**

All reagents should be of AR/GR quality.

### **8.1 Sampling**

**8.1.1 Distilled Water** - Must be reagent water as defined by ASTM procedure 1193-66 part 6.3 (consumption of potassium permanganate test).

**8.1.2 Sodium Hydroxide.**

**8.1.3 Sodium Arsenite - CAUTION** : Arsenic compounds are highly toxic and should be handled with extreme care. Avoid contact with skin and especially with eyes. Avoid generating dust or breathing dust. Keep away from food. Wash hands after handling it. Do not take internally.

**8.1.4 Absorbing Reagents** - Dissolve 4.0 g of sodium hydroxide in distilled water, add 1.0 g of sodium arsenite, and dilute to 1,000 ml with distilled water.

### **8.2 Analysis**

**8.2.1 Sulfanilamide** - Melting point 165 to 167°C.

- 8.2.2 **N-(1-Naphthyl)-ethylenediamine Di-hydrochloride (NEDA)** - A 1% aqueous solution should have only one absorption peak at 320 nm over the range of 260-400 nm. NEDA showing more than one absorption peak over this range is impure and should not be used.
- 8.2.3 Hydrogen Peroxide, 30%.
- 8.2.4 Phosphoric Acid, 85%.
- 8.2.5 **Sulfanilamide Solution** - Dissolve 20 g of sulfanilamide in 700 ml of distilled water. Add, with mixing, 50 ml of 85% phosphoric acid and dilute to 1,000 ml. This solution is stable for one month, if refrigerated.
- 8.2.6 **NEDA Solution** - Dissolve 0.5 g of NEDA in 500 ml of distilled water. This solution is stable for one month, if refrigerated and protected from light.
- 8.2.7 **Hydrogen Peroxide Solution** - Dilute 0.2 ml of 30% hydrogen peroxide to 250 ml with distilled water. This solution may be used for one month, if, refrigerated and protected from light.

## 9.0 PROCEDURE

### 9.1 Preparation of Calibration Graph

- 9.1.1 **Sodium Nitrite** - Assay of 97%  $\text{NaNO}_2$  or greater.
- 9.1.2 **Sodium Nitrite Stock Solution (1000  $\mu\text{g NO}_2^-/\text{ml}$ )** - Dissolve 1.5 g of desiccated sodium nitrite in distilled water and dilute to 1,000 ml such that a solution containing 1000  $\mu\text{g NO}_2^-/\text{ml}$  is obtained. The amount of  $\text{NaNO}_2$  to be used if, the assay percent is less than 100%, is calculated as follows :

$$G = \frac{1.500}{A}$$

**Where :**

- G = Amount of  $\text{NaNO}_2$ , grams  
 1.500 = Gravimetric conversion factor  
 A = Assay, percent (should be 97 or greater)

This stock solution can be stored for six weeks, if refrigerated.

### 9.1.3 Sodium Nitrite Working Standard (1.0 $\mu\text{g NO}_2^-/\text{ml}$ )

- 9.1.3.1 **Solution A** - Pipet 5 ml of the stock solution into a 500 ml volumetric flask and dilute to volume with distilled water. This contains 10  $\mu\text{g NO}_2^-/\text{ml}$ .

9.1.3.2 **Solution B** - Pipet 25 ml of solution A into a 250 volumetric flask and dilute to volume with absorbing solution. This contains 1  $\mu\text{g NO}_2/\text{ml}$ . Prepare fresh daily.

## 9.2 Calibration

9.2.1 **Flowmeter** - Calibrate the flowmeter against a calibrated flow measurement standard, such as a wet test meter, bubble flowmeter, or other reliable volume measurement standard. Calibrate in units of standard  $\text{cm}^3/\text{min}$  (i.e., corrected to  $25^\circ\text{C}$  and 760 torr).

9.2.2 **Absorber** - Calibrate the polypropylene absorber (see 8.1.2) by pipeting 50 ml of water or absorbing reagent into the absorber. Scribe the level of the meniscus with a sharp object, mark over the area with a felt-tip marking pen, and rub off the excess.

### 9.2.3 Spectrophotometer

9.2.3.1 Prepare calibration curve using 1  $\mu\text{g}/\text{ml}$  working standards (see 9.1.3.2).

9.2.3.2 In accordance with the analytical procedure given in 9.4, measure and record the absorbance for each calibration standard (0, 1, 2, 3, 4, 5, 6, 7, 8, 9, 10, 12, 15, 20  $\mu\text{g NO}_2$ ).

9.2.3.3 Plot absorbance (y-axis) versus the corresponding concentration in  $\mu\text{g NO}_2/50 \text{ ml}$  final solution (x-axis). Draw or compute the straight line best fitting the data to obtain the calibration curve.

## 9.3 Sample Collection

### 9.3.1 4-Hourly Sampling

9.3.1.1 Assemble the sampling apparatus (**Figure 1**) at the sampling site. Components upstream from the absorber may be connected, where required, with Teflon tubing; glass tubing with dry ball joints; or glass tubing with butt-to-butt joints with Teflon or polypropylene.

9.3.1.2 Add exactly 30 ml of absorbing reagent to the calibrated absorber.

9.3.1.3 Disconnect the funnel, connect the calibrated flowmeter, measure the flow rate before sampling and record as  $F_1$ . If the flow rate before sampling is not 1 Lpm, replace the flow control device and/or check the system for leaks. Start sampling only after obtaining an initial flow rate of 1 Lpm.

9.3.1.4 Sample for 4 hrs. Record the exact sampling time in minutes at  $t_s$ .

- 9.3.1.5 Measure the flow rate after the sampling and record as  $F_f$ .
- 9.3.1.6 Seal the collected samples and transport to the laboratory for analysis.

### 9.3.2 24-Hourly Sampling

- 9.3.2.1 Assemble the sampling apparatus (**Figure 1**) at the sampling site. Components upstream from the absorber may be connected, where required, with Teflon<sup>R</sup> or silicone tubing; glass tubing with dry ball joints; or glass tubing with butt-to-butt joints with Tygon<sup>R</sup>, Teflon<sup>R</sup>, or polypropylene.
- 9.3.2.2 Add exactly 30 ml of absorbing reagent to the calibrated absorber.
- 9.3.2.3 Disconnect the funnel, connect the calibrated flowmeter, measure the flow rate before sampling and record as  $F_1$ . If the flow rate before sampling is not between 180 and 220 cm<sup>3</sup>/min, replace the flow control device and/or check the system for leaks. Start sampling only after obtaining an initial flow rate in this range.
- 9.3.2.4 Sample for 24 hrs. Record the exact sampling time in minutes at  $t_s$ .
- 9.3.2.5 Measure the flow rate after the sampling period and record as  $F_f$ .
- 9.3.2.6 Seal the collected samples and transport to the laboratory for analysis.

## 9.4 Analysis

- 9.4.1 Replace any water lost by evaporation during sampling by adding distilled water up to the calibration mark on the absorber. Mix thoroughly.
- 9.4.2 Pipet 10 ml of the collected sample into a test tube. Pipet in 1 ml of hydrogen peroxide solution, 10 ml of sulfanilamide solution, and 1.4 ml of NEDA solution, with thorough mixing after the addition of each reagent and make up to 50 ml with distilled water.
- 9.4.3 Prepare a blank in the same manner using 10 ml of unexposed absorbing reagent.
- 9.4.4 After a 10 min color development interval, measure and record the absorbance at 540 nm against the blank.
- 9.4.5 Determine  $\mu\text{g NO}_2^-$  from the calibration curve (see 9.2.3.3).
- 9.4.6 Samples with an absorbance greater than 1.0 must be reanalyzed after diluting an aliquot of the collected samples with an equal quantity of unexposed absorbing reagent.

9.4.7 A randomly selected 5-10% of the samples should be reanalyzed as apart of an internal quality assurance program.

### 9.5 Sampling Efficiency

The overall average efficiency is 82% from 40 to 750  $\mu\text{g NO}_2/\text{m}^3$  (0.02 to 0.4 ppm)<sup>3</sup>.

## 10.0 CALCULATIONS

10.1 **Air Volume** - Calculate the volume of air samples as follows :

$$V = \frac{F_1 + F_f}{2} \times t_s \times 10^{-6}$$

Where :

- V = Volume of air sample, m<sup>3</sup>
- F<sub>1</sub> = Air flow rate before sampling, cm<sup>3</sup>/min
- F<sub>f</sub> = Air flow rate after sampling, cm<sup>3</sup>/min
- t<sub>s</sub> = Sampling time, min
- 10<sup>-6</sup> = Conversion of cm<sup>3</sup> to m<sup>3</sup>

If, the temperature and pressure conditions at the time of the initial and final air flow rate measurements are substantially different from the conditions under which the flowmeter was calibrated, appropriate corrections to the flow rate measurements may be made to improve the accuracy of the resultant NO<sub>2</sub> concentration measurement. The mathematical form of these corrections depends on the type of flowmeter used; consult an appropriate reference for guidance.

10.2 **NO<sub>2</sub> Concentration in Analyzed Sample** - Determine  $\mu\text{g NO}_2/\text{ml}$  graphically from the calibration curve or compute from the slope and intercept values (see 9.3.3).

10.3 **NO<sub>2</sub> Concentration in Air Sample** - Calculate as  $\mu\text{g}$  of NO<sub>2</sub> per cubic meter of air as follows :

$$\mu\text{g NO}_2/\text{m}^3 = \frac{\mu\text{g/NO}_2 \times V_s}{V_a \times 0.82 \times V_t} \times D$$

**Where :**

$\mu\text{g}/\text{NO}_2^-$  =  $\text{NO}_2^-$  concentration in analyzed sample

$V_a$  = Volume of air sample,  $\text{m}^3$

0.82 = Sampling efficiency

$D$  = Dilution factor ( $D = 1$  for no dilution;  $D = 2$  for 1:1 dilution).

$V_s$  = Final volume of sampling solution

$V_t$  = Aliquot taken for analysis

**10.4** The  $\text{NO}_2$  concentration may be calculated as ppm using :

$$\text{ppm NO}_2 = (\mu\text{g NO}_2/\text{m}^3) \times 5.32 \times 10^{-4}$$

**11.0 REFERENCES**

1. Christie, A.A. et. al. "Field method for the determination of Nitrogen dioxide in Air", *Analyst*, 95 : 510-524 (1970).
2. Margeson, J.H. et.al. "Evaluation of the sodium arsenite method for measurement of  $\text{NO}_2$  in ambient air". *J.A.P.C.A.*, 27 : 553-556 (1977).
3. Jacob, M.B. and Hochheiser, S. "Continuous sampling and ultra-micro determination of nitrogen dioxide in air". *Anal.Chem.*30 :426 (1958).
4. USEPA Designated Equivalent Method No. EQN-1277-026. 1977 Sodium Arsenite Method for the determination of Nitrogen dioxide in the atmosphere.



## 9. CONTINUOUS MEASUREMENT OF OXIDES OF NITROGEN IN AMBIENT AIR BY CHEMILUMINESCENCE

### 1.0 TITLE

Method for continuous measurement of oxides of nitrogen in ambient air by chemiluminescence.

### 2.0 PURPOSE

The purpose is to lay down a uniform and reliable method for measurement of oxides of nitrogen in ambient air.

### 3.0 PRINCIPLE

- 3.1 The measurement method is based upon the rapid chemiluminescent reaction of nitric oxide (NO) with excess ozone (O<sub>3</sub>) (1, 2). The reaction is made to take place in a light free chamber.

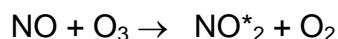

$$K = 1.0 \times 10^7 \text{ L mol}^{-1}\text{sec}^{-1}$$

A portion of the resultant nitrogen dioxide is produced in a highly excited energy state (NO<sup>\*</sup><sub>2</sub>) and subsequently decays to the ground level state emitting light in a broad frequency band with a peak at about 1200 nm :

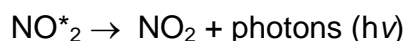

The intensity of the light emitted is linearly proportional to the nitric oxide concentration and is measured by a photomultiplier tube.

- 3.2 Atmospheric nitric oxide is determined directly in a sample stream as described in Section 3.1.
- 3.3 Atmospheric nitrogen dioxide in a sample stream is measured indirectly after conversion to nitric oxide. (Converters capable of this reduction are described in Section 8.1). The detection and determination of the total oxides of nitrogen (NO + NO from NO<sub>2</sub>) then proceeds as shown in Section 3.1. The NO<sub>2</sub> concentration is calculated by the subtraction of the measured NO concentration from the measured total oxides of nitrogen.

#### **4.0 SCOPE**

This method is applicable for measurement of oxides of nitrogen in ambient air.

#### **5.0 RANGE AND SENSITIVITY**

5.1 Instruments usually have multiple measurement ranges; typically 0 to 0.2, 0.5, 1.0 or 2.0 ppm v/v. For ambient monitoring, the most commonly used ranges are the 0 to 0.5 and 0 to 1.0 ppm v/v.

5.2 The lower detectable limit is determined by the instrument range being used. For the 0 to 0.5 ppm range a lower detectable limit of 0.01 ppm can be achieved (3).

#### **6.0 INTERFERENCES**

6.1 The chemiluminescent reaction of nitric oxide and ozone is not generally subject to interferences from commonly found pollutant species such as ozone, carbon monoxide and sulfur dioxide (4). However, any compound capable of being converted to nitric oxide in the instrument converter (Section 8.1.3) could be a possible interferent in the measurement of NO<sub>x</sub>. In this regard, gaseous ammonia could present a problem at elevated temperatures (600°C) in thermal converters; also certain organic nitrates and nitrites have been shown to decompose stoichiometrically to nitric oxide (5,6,7). Nitric acid reaching the converter is also decomposed to NO. A continuous method for measuring nitric acid at ambient levels based on a modified chemiluminescence analyzer has been reported (8).

#### **7.0 PRECISION AND ACCURACY**

7.1 Precision is defined by the stability and repeatability of response to NO. Response instability due to baseline drift should be equivalent to no more than  $\pm 0.020$  ppm v/v over a 24-h period, and the noise level to no more than  $\pm 0.005$  ppm v/v in the 0 to 0.5 ppm instrument range. Repeatability of response to a standard NO-air mixture should have a coefficient of variation not greater than 2%. This latter precision figure represents the composite error that is associated with both the NO measurement and the standardization operations (9).

7.2 Accuracy is dependent on the calibration equipment flow systems, and the absolute concentration of the NO standard gas cylinder. The calibration flow system specifications contained in the Section 10.2, together with a NO standard gas cylinder of Standard Reference Material (SRM) or Certified Reference Material (CRM) quality (Section 9.2) are capable of performing instrument calibrations to an accuracy of  $\pm 5\%$ .

## 8.0 APPARATUS

**8.1 Chemiluminescence Instrument** - Two basic instrument designs have been developed for the measurement of total oxides of nitrogen, nitric oxide and the indirect determination of nitrogen dioxide. In both cases, the determination of NO<sub>x</sub> (NO<sub>x</sub> = NO + NO<sub>2</sub>) and NO must be accomplished and the nitrogen dioxide calculated by subtraction of NO from the NO<sub>x</sub>. The two instrument configurations utilize the cyclic or dual mode of operation.

8.1.1 The cyclic mode instrument is shown schematically in **Figure-1**, and has a single reaction chamber and detector. The incoming sample air is alternately cycled directly to the reaction chamber to determine NO, or through the instrument converter to determine NO<sub>x</sub>. A normal cycle, which is approximately thirty (30) seconds, is accomplished by means of a timer controlled solenoid valve. Separate NO<sub>x</sub> and NO values are determined every thirty seconds. The photomultiplier tube outputs are amplified and stored in memory circuits; the difference output, nitrogen dioxide, is updated electronically after each cycle and similarly stored. Reorder outputs are available for all three measurement channels, NO, NO<sub>2</sub> and NO<sub>x</sub>.

8.1.2 The dual mode instrument is shown schematically in **Figure-2**, and has two reaction chambers and a single detector. The incoming air sample is split into two separate streams. The NO sample stream is routed directly to the reaction chamber, while the NO<sub>x</sub> sample stream first passes through the instrument converter before entering the second reaction chamber. An optical chopper alternately exposes the detector to the respective chemiluminescent outputs, generating continuous outputs for both NO and NO<sub>x</sub>. The outputs are amplified and stored in memory circuits; real-time NO<sub>2</sub> data obtained by difference are continuously generated. Reorder outputs are available for the NO, NO<sub>2</sub>, and NO<sub>x</sub> concentration.

8.1.3 *Converters* - For the accurate determination of nitrogen dioxide it is essential that the instrument converters have a high degree of efficiency (95%+) for the conversion of NO<sub>2</sub> to NO. The converters employed in commercially available instruments are of two basic types.

8.1.3.1 Thermal Converters are made of a high grade stainless steel and operate at elevated temperatures, 600-800°C. At these temperatures the breakdown of NO<sub>2</sub> into NO and O<sub>2</sub> occurs readily. These converters, though adequate for the breakdown of NO<sub>2</sub> to NO, have the obvious disadvantage of converting ammonia into NO (See Section 6).

8.1.3.2 Chemical converters are to be found in the majority of chemiluminescence instruments used for ambient monitoring. These converters have the advantage of a much lower operating temperature, 200-400°C, with efficient NO<sub>2</sub> conversion. Molybdenum and carbon converters have been in general use and are available in commercial instruments.

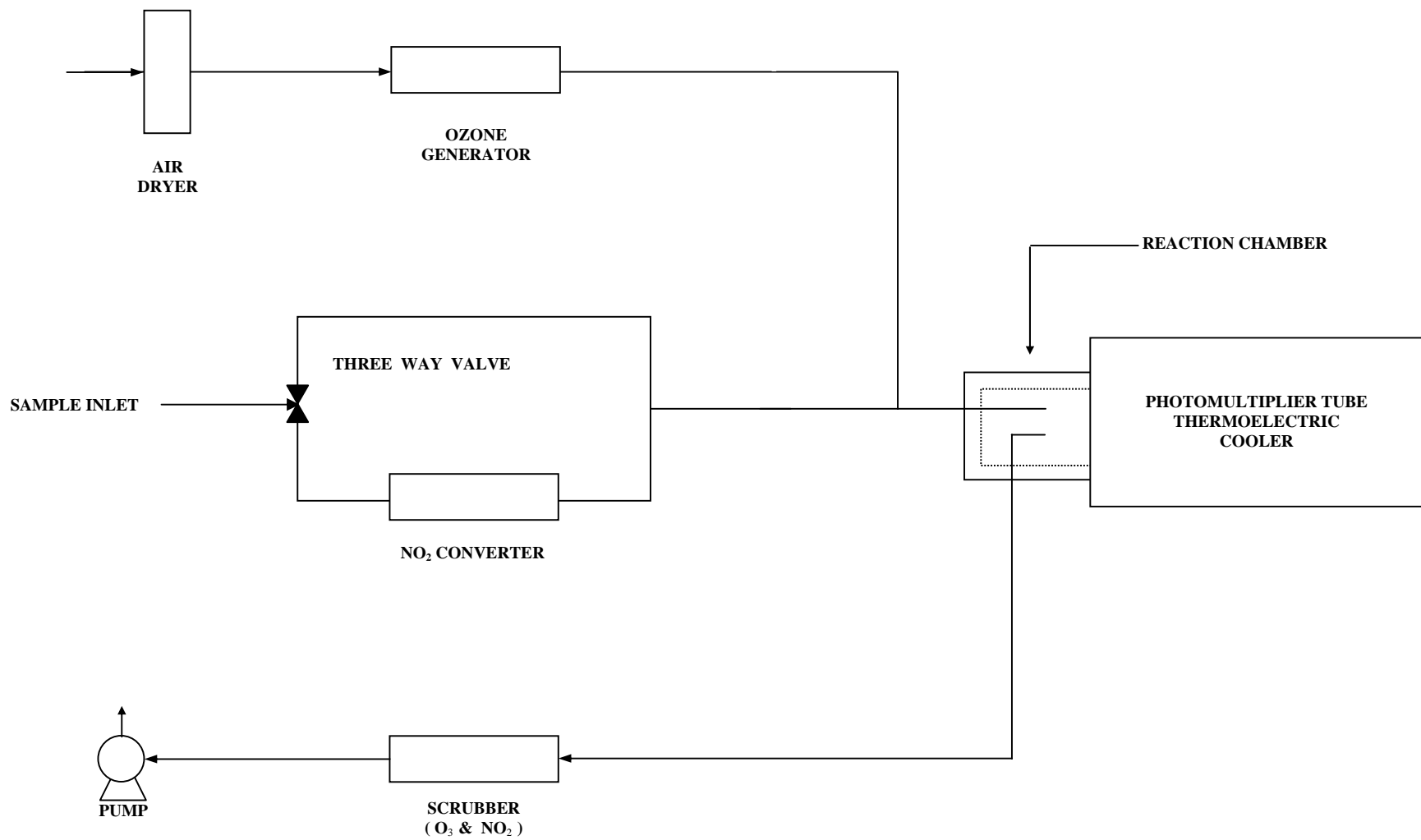

**FIG : 1 CYCLIC MODE CHEMILUMINESCENT ANALYZER.**

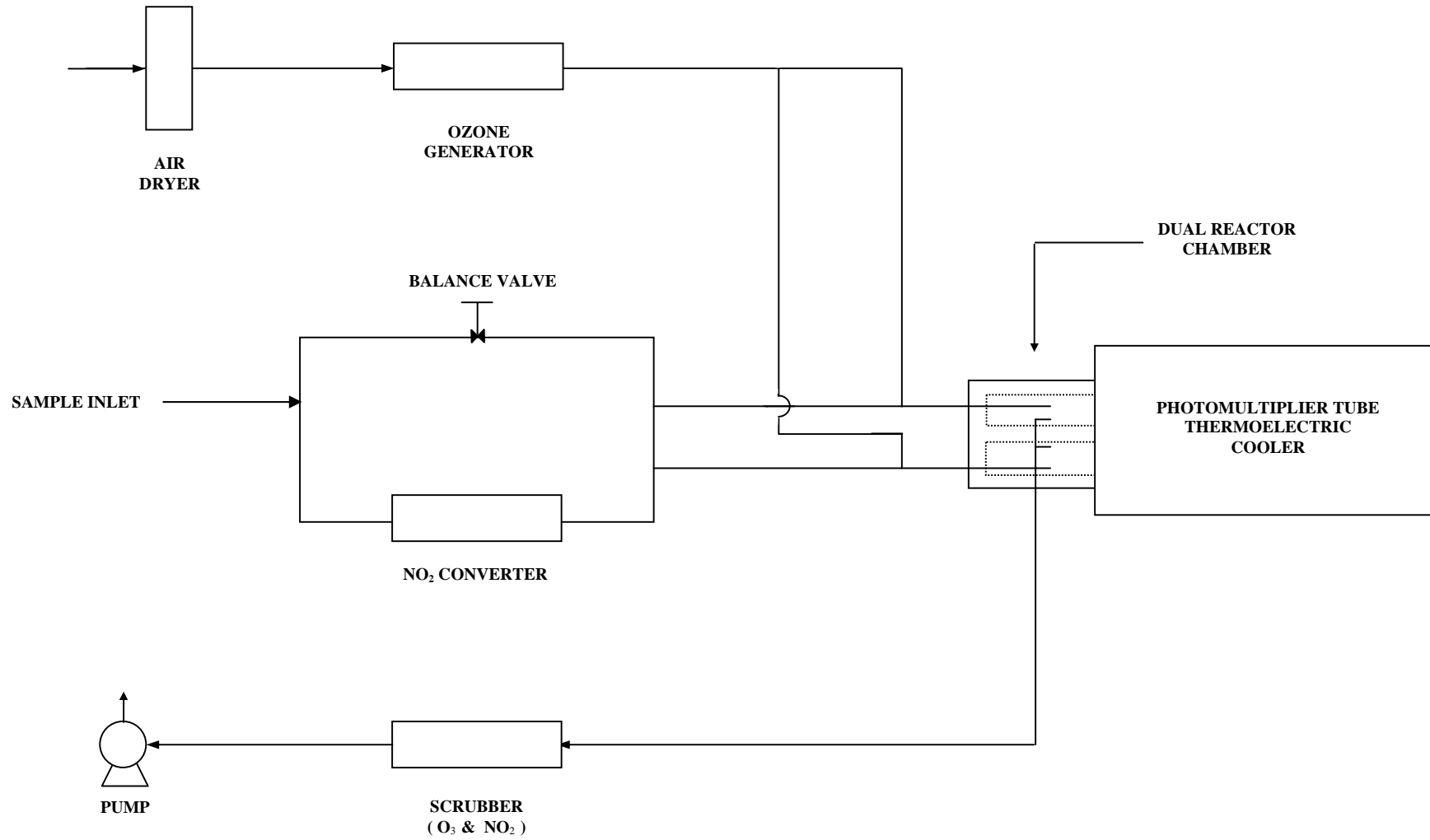

**FIG : 2 DUAL MODE CHEMILUMINESCENT ANALYZER**

- 8.2 **Recorder** - Capable of full-scale display of instrument output voltages.
- 8.3 **Air Inlet Filter** - A Teflon filter capable of removing all particulate matter greater than 5  $\mu\text{m}$  in diameter.
- 8.4 **Sample Lines** - The sample lines and all parts of the instrument that come in contact with the sample stream should be made of glass, Teflon or stainless steel.
- 8.5 **Vacuum Pump** - A pump capable of a minimum vacuum of 78kPa.

## 9.0 REAGENTS

- 9.1 **No Cylinder, Calibration Standard** - The NO standard should be traceable to a National or International Standard or a commercially available Certified Reference Material (CRM). Selection of the NO standard concentration is dependent on the operating range of the analyzer to be calibrated and on the dilution capability of the calibration system. NO cylinders normally used are in the  $25\text{-}59 \pm 2\%$  ppm v/v range in  $\text{N}_2$ . The NO calibration cylinder must be free of any nitrogen dioxide, and should be reanalysed on a regular basis, preferably every six months.
- 9.2 **Zero Air** - The air supply must be free of contaminants that would cause a detectable analyzer response, or react independently with NO.

## 10.0 CALIBRATION

- 10.1 In the procedure that follows, NO and  $\text{NO}_2$  calibrations are performed using a calibration system such as the one shown in **Figure-3**. Nitric oxide calibrations are performed by dynamic flow dilution of a NO standard with a clean air stream. Nitrogen dioxide calibrations are performed by the rapid gas phase reaction between NO and  $\text{O}_3$  to provide a stoichiometric quantity of  $\text{NO}_2$ , equal to the decrease in the NO concentration. The reaction is the same as shown as Section 3.1, except that the NO remains in excess rather than the ozone as described in 3.1. This reaction is commonly referred to as Gas Phase Titration (GPT) (9). An alternative  $\text{NO}_2$  procedure, not described herein, is the generation of known test atmospheres by means of a  $\text{NO}_2$  permeation device (10).
- 10.2 **Calibration System**- All components in the calibration system such as the one in **Figure-3** should be made of glass, Teflon or stainless steel. The system is designed to provide dynamic dilution for NO and GPT for  $\text{NO}_2$ . The dilution

**FIG. 3 CALIBRATION SYSTEM COMPONENTS**

section comprises two independent flow controls that can be varied individually to provide a dilution ration of up to 1,000 to 1. The GPT section comprises a current-regulated ozone generator through which a portion of the dilution air flows even when the ozonator is not in operation. For dynamic dilution, the metered NO combines with this portion of the dilution air and passes through the reaction chamber. It then combines with the balance of the dilution air and passes through the sampling manifold. For GPT the flow path is the same except that a portion of the oxygen in the air passing through the ozone generator is converted to ozone.

- 10.2.1 **Air Flow Controller** - A device capable of maintaining constant clean-air flow up to 5 L/min within  $\pm 2\%$  of the required flow rate.
- 10.2.2 **Air Flowmeter** - A calibrated flowmeter capable of measuring air flow rates within  $\pm 2\%$ .
- 10.2.3 **Nitric Oxide Flow Controller** - A device capable of maintaining constant NO flow within  $\pm 2\%$  of the required flow rate.
- 10.2.4 **Nitric Oxide Flowmeter** - A calibrated flowmeter capable of measuring NO flow rates within  $\pm 2\%$ .
- 10.2.5 **Two-Stage Regulator** - The two-stage pressure regulator for the standard NO cylinder must be of stainless steel to prevent any reaction of the NO gas.
- 10.2.6 **Ozone Generator** - The generator must be capable of generating stable levels of O<sub>3</sub> for the GPT of NO to provide NO<sub>2</sub> concentrations throughout the calibration range.
- 10.2.7 **Reaction Chamber** - The chamber used for the reaction of O<sub>3</sub> with excess NO should be of sufficient volume that the residence time is not less than 2 minutes (11).
- 10.2.8 **Mixing Chamber** - A chamber used to allow thorough mixing of reaction products and dilution air.
- 10.2.9 **Sampling Manifold** - The sampling manifold should be of adequate design to insure against any pressure buildup. It must have a vent to insure atmospheric pressure at the manifold, and for safety considerations to direct excess calibration air streams to an exhaust system.
- 10.3 **Procedure** - Prior to start of calibration, for safety purposes, insure proper venting of the analyzer exhaust and the calibration system have excess flow. Insure that the analyzer and the calibration system have been on for a time sufficient to provide stable operation.



10.3.1 **Flow Conditions** - Insure that the air and gas flow systems are calibrated under the conditions of use against an authoritative standard. Different output calibration gas concentrations are obtained simply by changing the ratios of flow rates between the NO and dilution air channels. It is preferable to maintain a constant dilution air-flow and to vary the NO flow. The total flow required at the sampling manifold should equal the analyzer demand plus at least 50% excess. The following equations can be used to pre-calculate the specific gas dilution air-flow rates required for the desired calibration points, usually 20, 40, 60 and 80% of the instrument range.

$$S = \frac{STD \times FS}{FS + FD} \quad (1)$$

**Where :**

S = desired output concentrations of NO in ppm  
 STD = NO standard cylinder concentration in ppm  
 FS = NO standard cylinder flow rate  
 FD = dilution air flow rate in cm<sup>3</sup>/min.

Solving equation (1) for the NO standard flow rate (FS) that will produce the desired concentration for a given dilution flow rate (FD) gives :

$$FS = \frac{S \times FD}{STD - S} \quad (2)$$

**Example :** For a corrected dilution flow FD = 5.00 L/min. a NO cylinder concentration STD = 100 ppm v/v, and a desired output concentration S = 0.90 ppm, we substitute into equation (2) and obtain for the NO standard flow rate.

$$FS = \frac{(0.90) \times (5,000)}{(100) - (0.90)} = 45.4 \text{ cm}^3/\text{min}$$

10.3.2 **Zero Calibration** - Activate the zero air source and allow the analyzer to sample the zero air until a stable zero response is obtained. Adjust the analyzer NO<sub>x</sub>, NO and NO<sub>2</sub> zero controls as described in the instrument manual. It is good practice to recheck the zero at the end of the multipoint calibration, especially if large span adjustments were made.

10.3.3 **Preparation for the NO and NO<sub>x</sub> Calibration** - Set the zero air and NO standard flow rates as determined in 10.3.1 for generating a NO concentration at

80% of the instrument range setting. Sample this NO concentration for a minimum of 15 minutes or until the NO and NO<sub>x</sub> responses are stable.

10.3.3.1 *NO and NO<sub>x</sub> Span Adjustment* - Adjust as necessary the analyzer NO and NO<sub>x</sub> span controls to obtain recorder responses equal to the NO (NO<sub>x</sub> in this case as well) concentration generated.

**Note :** Some analyzers may have separate span controls for NO, NO<sub>x</sub> and NO<sub>2</sub>. Other analyzers may only have separate controls for NO and NO<sub>x</sub>, while others may have one span control common to all channels. Always refer to the instrument manual for any necessary adjustments.

10.3.3.2 Generate additional concentrations evenly spaced across the remainder of the instrument operating scale to establish linearity by decreasing the flow of the NO standard. For each concentration generated, calculate the NO and NO<sub>x</sub> concentrations and insure that the respective recorder outputs of the NO and NO<sub>x</sub> channels are correct.

10.3.4 *Preparation for the NO<sub>2</sub> Calibration* - Set the dilution air and NO standard flow rates as determined in 10.3.1 for generating a NO concentration of about 80% of the instrument range setting. Sample this NO concentration for a minimum of 15 minutes or until the NO, NO<sub>x</sub> and NO<sub>2</sub> recorder responses are stable. Record the readings.

**Note :** The NO<sub>2</sub> calibration is conveniently performed by reestablishing the 80% of scale NO-NO<sub>x</sub> calibration point, using the same dilution air and NO standard flow rates used in 10.3.3.

10.3.4.1 *Gas Phase Titration* - Activate the ozone generator and adjust the ozone output so as to decrease the NO concentration by approximately 80%. The decrease must not exceed 90% of the NO concentration being sampled prior to the GPT. Sample this NO-NO<sub>2</sub> mixture for a minimum of 15 minutes or until the NO, NO<sub>x</sub> and NO<sub>2</sub> recorder responses are stable. Record the readings. Calculate the indicated NO<sub>2</sub> concentration as per Section 11.1.

10.3.4.2 *Nitrogen Dioxide Span Adjustment* - Adjust as necessary the analyzer NO<sub>2</sub> span control to obtain a recorder response equal to the calculated NO<sub>2</sub> concentration.

10.3.4.3 Generate at least two additional calibration points evenly spaced across the remainder of the instrument operating scale by decreasing the O<sub>3</sub> output while maintaining the dilute air and NO standard flow

rates constant. For each calibration point generated, calculate the NO<sub>2</sub> concentration, and insure that the NO<sub>2</sub> recorder responses are correct.

10.3.4.4 **Determination of Converter Efficiency** - Calculate the analyzer converter efficiency as per Section 11.2 for the NO<sub>2</sub> concentration generated in Section 10.3.4.1. The converter efficiency must be 95% or greater to be acceptable.

## 11.0 CALCULATIONS

11.1 Calculation of NO<sub>2</sub> concentration

$$\text{NO}_2 = \text{NO}_x - \text{NO}$$

**Where :**

NO<sub>x</sub> = instrument reading of the NO<sub>x</sub> channel (10.3.4)

NO = instrument reading of the NO channel (10.3.4.1)

11.2 Calculation of Converter Efficiency (CE)

$$\text{Converter Efficiency} = \frac{[\text{NO}_x]}{[\text{NO}_x]_{\text{GPT}}} \times 100$$

**Where :**

[NO<sub>x</sub>] = instrument response for original NO<sub>x</sub> concentration prior to GPT (10.3.4)

[NO<sub>x</sub>]<sub>GPT</sub> = instrument response for NO<sub>x</sub> during the GPT runs (10.3.4.1)

## 12.0 REFERENCES

1. A. FONTIJN, A.J. SABADELL AND R.J. RONCO. 1970. "Homogeneous Chemiluminescent Measurement of Nitric Oxide with Ozone", Anal. Chem., 42:575.
2. D.H. STEDMAN, E.E. DABY, F. STUHL AND H. NIKI. 1972. "Analysis of Ozone and Nitric Oxide by a Chemiluminescent Method in Laboratory and Atmospheric Studies of Photochemical Smog", J. Air Poll. Control Assoc., 22:260.
3. B.E. MARTIN, J.A. HODGESON AND R.K. STEVENS. 1972. "Detection of Nitric Oxide Chemiluminescence at Atmospheric Pressure", Presented at 164<sup>th</sup> National ACS Meeting, New York City.

4. R.K. STEVENS AND J.A. HODGESON. 1973. "Application of Chemiluminescent Reactions to the Measurement of Air Pollutants", Anal. Chem. 45:443A.
5. J.A. HODGESON, K.A. REHME, B.E. MARTIN AND R.K. STEVENS. 1972. "Measurement of Atmospheric Oxides of Nitrogen and Ammonia by Chemiluminescence", Reprint, Presented at 1972 APCA Meeting, Miami, Florida.
6. L.P. BREITENBACH AND M. SHELEF. 1973. "Development of a Method for the Analysis of NO<sub>2</sub> and NH<sub>3</sub> by NO-Measuring Instruments", J. Air Poll. Control Assoc., 23:128.
7. A.M. WINER, J.W. PETERS, J.P. SMITH AND J.N. PITTS, JR., 1974. "Response of Commercial Chemiluminescent NO- NO<sub>2</sub> Analyzers to Other Nitrogen-Containing Compounds", Envir. Sci. Tech., 8:1118.
8. D.W. JOSEPH AND C.W. SPICER. 1978. "Chemiluminescence Method for Atmospheric Monitoring of Nitric Acid and Nitrogen Oxides. Anal. Chem. 50:1400-1403.
9. K.A. REHME, B.E. MARTIN AND J.A. HODGESON. 1974. "Tentative Method for the Calibration of Nitric Oxide, Nitrogen Dioxide and Ozone Analyzers by Gas Phase Titration", EPA-R2-73-246.
10. F.P. SCARINGELLI, A.E. O'KEEFFE, E. ROSENBERG AND J.P. BELL. 1970. "Preparation of Known Concentration of Gases and Vapors with Permeation Devices Calibrated Gravimetrically, Anal. Chem., 42:871.
11. E.C. Ellis. 1975. "Technical Assistance Document for the Chemiluminescence Measurement of Nitrogen Dioxide", EPA-E600/4-75-003.

## 10. DETERMINATION OF OZONE IN THE ATMOSPHERE

### 1.0 TITLE

Method for determination of Ozone in the Atmosphere (Chemical Method).

### 2.0 PURPOSE

The purpose is to lay down an uniform and reliable method for sampling and analysis of ozone in ambient air.

### 3.0 PRINCIPLE

3.1 Micro-amounts of ozone and the oxidants liberate iodine when absorbed in a 1% solution of potassium iodine buffered at pH 6.8  $\pm$  0.2. The iodine is determined spectrophotometrically by measuring the absorption of triiodide ion at 352 nm.

3.2 The stoichiometry is approximated by the following reaction :

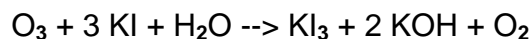

3.3 This method covers the manual determination of oxidant concentrations between 0.01 to 10 ppm (19.6 to 19620  $\mu\text{g}/\text{m}^3$ ) as ozone (1).

3.4 When 10 ml of absorbing solution is used, between 1 and 10  $\mu\text{l}$  of ozone, corresponding to absorbance between 0.1 and 1 in a 1 cm cell, are collected.

3.5 The precision of the method within the recommended range (Section 3.2) is about  $\pm$  5% deviation from the mean. The major error is from loss of iodine during sampling periods; this can be reduced by using a second impinger.

3.6 The accuracy of this method has not been established for atmospheric sampling.

3.7 The method was compared against an absolute ultraviolet photometer (8). In the range of 40-60% relative humidity (see section 7.6) the ozone-iodine stoichiometry was 1.25 and not 1.00 as suggested by the equation in Section 3.2.

### 4.0 SCOPE

This method is applicable for measurement of ozone present in ambient air.

### 5.0 INTERFERENCES

5.1 Sulfur dioxide produces a negative interference equivalent to 100% of that of an equimolar concentration of oxidant.

- 5.1.1 Up to 100 fold ratio of sulfur dioxide to oxidant may be eliminated with out loss of oxidant by incorporating a chromic acid paper absorber in the sampling train upstream from the impinger (2).
- 5.1.2 The absorber removes sulfur dioxide without loss of oxidant but will also oxidize nitric oxide to nitrogen dioxide.
- 5.1.3 When sulfur dioxide is less than 10% of the nitric oxide concentration, the use of chromic acid paper is not recommended. In this case, the effect of sulfur dioxide on the oxidant reading can be corrected for by concurrently analyzing for sulfur dioxide and adding this concentration to the total oxidant value.
- 5.2 Nitrogen dioxide is known to give a response in 1% KI (1), equivalent to 10% of that of an equimolar concentration of ozone. The contribution of nitrogen dioxide to the oxidant reading can be eliminated by concurrently analyzing for nitrogen dioxide by an appropriate method from this volume and subtracting one-tenth of the nitrogen dioxide concentration from the total oxidant value.
- 5.3 Peroxyacetyl nitrite gives approximately a response equivalent to 50% of that of an equimolar concentration of ozone (3). Concentrations in the atmosphere may range up to 0.1 ppm.
- 5.4 Other oxidizing substances besides ozone will liberate iodine with this method : e.g., halogens, proxy compounds, hydro-peroxides, organic nitrites and hydrogen peroxide (4, 5).
- 5.5 Hydrogen sulfide, reducing dusts or droplets can act as negative interferences.
- 5.6 It has been shown that the amount of iodine formed increases with relative humidity during sampling (6, 7). This effect is nearly linear. Increase of iodine formation is 0-10% with RH values ranging from 0-60%. Insignificant effects were observed by increases of RH from 60 to 75%.

## **6.0 SAMPLE PRESERVATION**

- 6.1 Ozone liberates iodine through both a fast and a slow set of reactions. Some of the organic oxidants also have been shown to cause slow formation of iodine (4, 5). Some indication of the presence of such oxidants and of gradual fading due to reductant can be obtained by making several readings during an extended period of time, e.g., every 20 min.
- 6.2 Occasionally mold may grow in the absorbing reagent. When this occurs discard the reagent because reducing substances and a change in pH make it useless.

## 7.0 APPARATUS

- 7.1 **Sampling Probe** - Sampling probes should be of Teflon, glass or stainless steel. Ozone is destroyed by contact with polyvinyl chloride tubing and rubber even after a conditioning period. Short sections of polyvinyl chloride tubing can be used to secure butt-to-butt connections of more inert tubing.
- 7.2 **Air Metering Device** - A glass rotameter capable of measuring gas flows of 0.5 to 3 l/min calibrated with a wet test meter to assure an accuracy of  $\pm 2\%$ .
- 7.3 **Absorber** - All-glass midget impingers graduated with 5 ml graduations should be used. Impingers should be kept clean and dust free. Cleaning should be done with laboratory detergent followed by rinses with tap and distilled water.
- 7.3.1 Do not use fritted glass bubblers as these produce less iodine (9)
- 7.4 **Air Pump** - Any suction pump capable of drawing the required sample flow for intervals up to 30 min. It is desirable to have a needle valve or critical orifice (10) for flow control. A trap should be installed upstream of the pump to protect against accidental flooding with absorbing solution and consequent corrosion.
- 7.5 **Spectrophotometer** - Any laboratory instrument capable of accurately measuring the absorbance of the triiodide ion at 352 nm. Stoppered cuvette or tubes transparent in the near ultraviolet region should be used to hold the solutions.

## 8.0 REAGENTS

- 8.1 **Purity** - AR/GR grade chemicals shall be used in all tests. Other grades may be used provided it is first ascertained that the reagent is of sufficiently high purity to permit its use without lessening the accuracy of the determination.
- 8.2 **Water** - Water means ASTM reagent water, Type II.
- 8.3 **Absorbing Solution (1% KI in 0.1 m Phosphate Buffer)** - Dissolve 13.6 g of potassium dihydrogen phosphate ( $\text{KH}_2\text{PO}_4$ ), 14.2 g of disodium hydrogen phosphate ( $\text{Na}_2\text{HPO}_4$ ) or 35.8 g of the dodecahydrate salt ( $\text{Na}_2\text{HPO}_4 \cdot 12 \text{H}_2\text{O}$ ), and 10.0 g of potassium iodide in sequence and dilute the mixture to 1 L with water. Keep at room temperature for at least 1 day before use. Measure pH and adjust to  $6.8 \pm 0.2$  with NaOH or  $\text{KH}_2\text{PO}_4$ . This solution can be stored for several months in a glass stoppered brown bottle at room temperature without deterioration. It should not be exposed to direct sunlight.
- 8.4 **Stock Solution 0.025 M  $\text{I}_2$  (0.05N)** - Dissolve 16 g of potassium iodide and 3.173 g of re-sublimed iodine successively and dilute the mixture to exactly 500 ml with water. Keep at room temperature at least 1 day before use. Standardize shortly

before use, against 0.025 M  $\text{Na}_2\text{S}_2\text{O}_3$ . The sodium thiosulfate is standardized against primary standard biiodate [ $\text{KH}(\text{IO}_3)_2$ ] or potassium dichromate ( $\text{K}_2\text{Cr}_2\text{O}_7$ ).

- 8.4.1 **0.001 M  $\text{I}_2$  Solution** - Pipet exactly 4.00 ml of the 0.025 M Stock solution into a 100 ml low actinic volumetric flask and dilute to the mark with absorbing solution. Protect from strong light. Discard after use.
- 8.4.2 **Calibrating Iodine Solution** - For calibration purposes exactly 5.11 ml of the 0.001 M  $\text{I}_2$  solution (or equivalent volume for other molarity) is diluted with absorbing solution just before use to 100 ml (final volume) to make the final concentration equivalent to 1  $\mu\text{l}$  of  $\text{O}_3/\text{ml}$ . This solution preparation accounts for the stoichiometry described in Section 3.7 at standard conditions of 101.3 kPa and 25°C. Discard this solution after use.
- 8.5 **Sulfur Dioxide Absorber** - Flash-fired glass fiber paper is impregnated with chromium trioxide, as follows (2) : Drop 15 ml of aqueous solution containing 2.5 g chromium trioxide and 0.7 ml concentrated sulfuric acid uniformly over 400  $\text{cm}^2$  of paper, and dry in an oven at 80 to 90°C for 1 hour; store in a tightly capped jar. Half of this paper suffices to pack one absorber. Cut the paper in 6 x 12 mm strips, each folded once into a V-shape, pack into an 85 ml U-tube or drying tube, and condition by drawing air that has been dried over silica gel through the tube overnight. The absorber is active for at least one month. When, it becomes visibly wet from sampling humid air, it must be dried with dry air before further use.

## 9.0 PROCEDURE

- 9.1 Assemble a train consisting of a rotameter, U-tube with chromium trioxide paper (optional), midget impinger, needle valve or critical orifice (10) and pump. Connections upstream from the impinger should be ground glass or inert tubing but joined with polyvinyl tubing. Fluorosilicon or fluorocarbon grease should be used sparingly. Pipet exactly 10 ml of the absorbing solution into the midget impinger. Sample at a rate of 0.5 to 3 L/min for up to 30 min. The flow rate and the time of sampling should be adjusted to obtain a sufficiently large concentration of oxidant in the absorbing solution. Approximately 1  $\mu\text{l}$  of ozone can be obtained in the absorbing solution at an atmospheric concentration of 0.01 ppm by sampling for 30 min at 3 L/min. Calculate the total column of the air sample. Also measure the air temperature and pressure. Do not expose the absorbing reagent to direct sunlight.
- 9.2 **Measurement of Color** - If, appreciable evaporation of the absorbing solution occurs during sampling, add water to bring the liquid volume to 10 ml.
- 9.3 Within 30 to 60 minutes after sample collection, read the absorbance in a cuvette or tube at 352 nm against a reference cuvette or tube containing water.



9.4 **Blank Correction** - Measure the absorbance of the unexposed reagent and subtract the value from the absorbance of the sample.

### 9.5 Calibration and Standardization

9.5.1 Calibrating solutions are made up to 10 ml to facilitate the calculations:

9.5.2 Obtain a range of calibration points containing from 1 µl to 10 µl of ozone equivalent per 10.0 ml of solution. Prepare by individually adding 1.0, 2.0, 4.0, 6.0, 8.0 and 10.0 mL of the calibrating iodine solution (Section 9.4.2) to 10.0 ml volumetric flasks. Bring each to the calibration mark with absorbing reagent.

9.5.3 Read the absorbance of each of the prepared calibration solutions as described in Section 10.3 and 10.4.

9.5.4 Plot the absorbance of the obtained colors against the concentration of O<sub>3</sub> in µl/10 ml absorbing reagent. The plot follows Beer's law. Draw the straight line through the origina giving the best fit, or fit by least squares. Do not extrapolate beyond the highest concentration.

## 10.0 CALCULATIONS

10.1 Standard conditions are taken as 101.3 kPa and 25°C, at which the molar gas volume is 24.47 liters.

10.2 Record the volume of sample collected in liters. Generally the correction of the sample volume to standard conditions is slight and may be omitted. However, for greater accuracy corrections may be calculated by means of the perfect gas laws.

10.3 The total µl of O<sub>3</sub>/10 ml of reagent are read from the calibration curve.

10.4 The concentration of O<sub>3</sub> in the gas phase in µl/l or ppm is given by :

$$\text{O}_3 \text{ ppm} = \frac{\text{Total } \mu\text{l ozone per 10 ml}}{\text{Volume of air sample, L}}$$

10.5 The concentration of O<sub>3</sub> in terms of µg/m<sup>3</sup> at 101.3 kPa and 25°C is obtained when desired from the value of µl/l (Section 11.4) by :

$$\begin{aligned} \mu\text{g O}_3/\text{m}_3 &= \frac{\text{ppm} \times 48.00}{24.47} \times 10^3 \\ &= 1962 \times \text{ppm} \end{aligned}$$

## 11.0 REFERENCES

1. Byers, D.H. and B.E. Saltzman, 1958. Determination of Ozone in Air by Neutral and Alkaline Iodide Procedures. *J. Am. Indust. Hyg. Assoc.* 19:251-7.
2. Saltzman, B.E. and A.F. Wartburg, 1965. Absorption Tube for Removal of Interfering Sulfur Dioxide in Analysis of Atmospheric oxidant. *Anal. Chem.* 37:779.
3. Mueller, P.K., F.P. Terraglio and Y. Tokiwa, 1965. Chemical Interferences in Continuous Air Analysis. Proc., 7th Conference on Methods in Air Pollution Studies, State of California Department of Public Health, Berkeley, California.
4. Saltzman, B.E. and N. Gilbert, 1959. Iodometric Microdetermination of Organic Oxidants and Ozone. *Anal. Chem.* 31:1914-20.
5. Altschuller, A.P., C.M. Schwab and M. Bare, 1959. Reactivity of Oxidizing Agents with Potassium Iodide Reagent. *Anal. Chem.* 31:1987-90.
6. Higuchi, J.E., F.R. Leh and R.D. Macphee, 1976. Comparison of Oxidant Measurement Methods, Ultraviolet Photometry, and Moist Effects, APCA Technical Specialty Conference on Ozone/Oxidants-Interaction with the Total Environment. Dallas, TX.
7. California Air Resources Board Report (Joint study of the Los Angeles County APCD, CARB and the U.S. Environmental Protection Agency), 1975. A study of the Effect of Atmospheric Humidity on Analytical Oxidant Measurement Methods, Sacramento, C.A.
8. Demore, W.B., J.C. Romanovsky, W.J. Hamming, M. Feldstein and P.K. Mueller, 1976. Interagency Comparison of Iodometric Methods for Ozone Determination. Calibration in Air Monitoring, ASTN-STP 598. American Society of Testing and Materials.
9. Cohen, I.C., A.F. Smith and R. Wood, 1968. A Field Method for the Determination of Ozone in the Presence of Nitrogen Dioxide. *Analyst*, 93:509.
10. Lodge, J.P., JR., J.B. Pate, B.F. Ammons and G.A. Swanson, 1966. The use of Hypodermic Needles as Critical Orifices in Air Sampling. *Air Poll Control Assoc. J.* 16:197-200.

# 11. CONTINUOUS MEASUREMENT OF OZONE IN THE ATMOSPHERE BY ULTRAVIOLET PHOTOMETRIC INSTRUMENTS

## 1.0 TITLE

Method for continuous measurement of Ozone in the atmosphere by Ultraviolet Photometric Instruments.

## 2.0 PURPOSE

The purpose is to lay down a uniform and reliable method for measurement of ozone in ambient air.

## 3.0 PRINCIPLE

3.1 The method is based on the photometric assay of ozone (O<sub>3</sub>) concentrations in a dynamic flow system. The concentration of O<sub>3</sub> is determined in an absorption cell from the measurement of the amount of light absorbed at a wavelength of 254 nm. The method is based on the absorption coefficient of O<sub>3</sub> at 254 nm, the optical path length through the sample, and the transmittance, temperature and pressure of the sample (1,2,3,4,5). The quantities above are related by the Beer-Lambert absorption law.

$$\text{Transmittance} = \frac{I}{I_0} = e^{-\alpha c l}$$

Where :

$\alpha$  = absorption coefficient of O<sub>3</sub> at 254 nm = 310 atm<sup>-1</sup> cm<sup>-1</sup> at 0°C and 101.3 kPa

$e$  = O<sub>3</sub> concentration in units of atmosphere

$l$  = optical path of absorption cell length in cm

$I$  = intensity of light passing through cell with an ozone sample

$I_0$  = intensity of light passing through cell with zero air

Typically, an air sample is first directed through a scrubber that removes any O<sub>3</sub> present, but otherwise does not affect the sample. The ozone-free sample then flows through the absorption cell, and its transmittance is measured. This constitutes the zero cycle. At a present time, solenoid switches and another air sample flows directly into the absorption cell, bypassing the scrubber and its transmittance is measured. This constitutes the ozone measurement cycle. The difference in transmittance between the two cycles is a measure of the O<sub>3</sub> concentration. The complete measurement cycle takes about 20 to 30 s.

Microprocessor-controlled electronics perform timing functions, condition the signal and perform arithmetic operations in commercially available analyzers. **Figure-1** and **2** show typical flow systems for both single and dual cell O<sub>3</sub> analyzers.

#### **4.0 SCOPE**

This method is applicable for measurement of ozone in ambient air.

#### **5.0 RANGE AND SENSITIVITY**

**5.1** O<sub>3</sub> analyzers are commercially available for measurement in the 0.00 to 1.00 ppm (1962 µg/m<sup>3</sup>) range.

**5.2** The lower limit of detection has been reported at 1 ppm (1.96 µg/m<sup>3</sup>) (8).

#### **6.0 INTERFERENCES**

**6.1** Any gaseous component or fine particle that absorbs or scatters light 254 nm is a potential interferent. Gaseous components normally found in ambient air do not interfere, and particles are largely removed by the teflon filter described in Section **8.2**. Specific interference from nitrogen dioxide and sulfur dioxide has been evaluated and found to be negligible (9).

#### **7.0 PRECISION AND ACCURACY**

**7.1** Precision audits of thirty-three analyzers revealed an average standard deviation of 4.3% from a reference sample. The average percent difference from the known value was -3.0% with 95% probability limits of +8% and -13% (10).

**7.2** In a controlled experiment, photometers operated by four different laboratories indicated a total variation of 2.8% when measuring O<sub>3</sub> concentrations from 0.05 to 0.70 ppm (98 TO 1373 µg/m<sup>3</sup>). For ozone analyzers, the accuracy is determined by the calibration. When calibrations are performed using photometers, ± 0.01 ppm is obtainable. If the neutral buffered potassium iodide spectrophotometric procedure (Reference of Ozone method by wet chemical method is to be given) is used, an overall average of ± 5% can be used.

#### **8.0 APPARATUS**

**8.1** ***Ozone Photometric Analyzer*** - Commercially available, complete with sample pump and sample flowmeter.

**8.1.1** All connections to the ozone and analyzer must be constructed of glass, Teflon or other inert materials (12).

**FIG. 1 SCHEMATIC DIAGRAM OF A TYPICAL SINGLE CELL OZONE ANALYSER**

**FIG. 2 SCHEMATIC DIAGRAM OF A TYPICAL DUST CELL OZONE ANALYSER**

8.2 **Air Inlet Filter** - A Teflon filter capable of removing all particulate matter greater than 5  $\mu\text{m}$  in diameter.

8.3 **Recorder** - Capable of full scale display of voltages from the instrument DC amplifier. These are commonly found in full scale ranges of 10 mV to 1V.

#### 8.4 **Calibration Apparatus**

8.4.1 **Ultraviolet Photometer, (UV Photometer)**, commercially available. The UV photometers are primary standards for determinations of ozone in air. The units differ from the ozone photometric analyzer in Section 8.1 in that the UV photometers do not contain an ozone scrubber, and are designed to make pressure and temperature corrections for the measured ozone to standard conditions (25°C and 101.3kPa).

8.4.2 **Ozone Transfer Standard** - An ozone analyzer that has been precalibrated against a UV photometer (13).

8.4.3 **Ozone Source and Dilution System** - The ozone source consists of a quartz tube into which purified air is introduced and then irradiated with a stable low pressure mercury lamp. The level of irradiation is controlled by an adjustable metal sleeve that fits around the lamp (14). At a fixed level of irradiation and at a constant temperature and humidity, ozone is produced at a uniform rate. By careful control of the flow of air through the quartz tube, and/or adjustment of the irradiation level, test atmospheres can be generated that contain stable but variable concentrations of ozone. An output manifold with a vent is attached to the ozonator (**Figure-3**). Ozone outputs must be available to cover the complete analyzer operating range, typically 0.00 to 1.00 ppm. The dilution system should have a total flow capability of at least 5 l/min. Any alternative system capable of these outputs is acceptable (15).

8.4.4 **Spectrophotometric** determination of the calibration ozone streams may be performed. This manual method is based on the formation of free iodine in a neutral buffered potassium iodide solution upon exposure, and required the following equipment :

8.4.4.1 Air metering device

8.4.4.2 Midget impingers

8.4.4.3 Air pump

8.4.4.4 Spectrophotometer

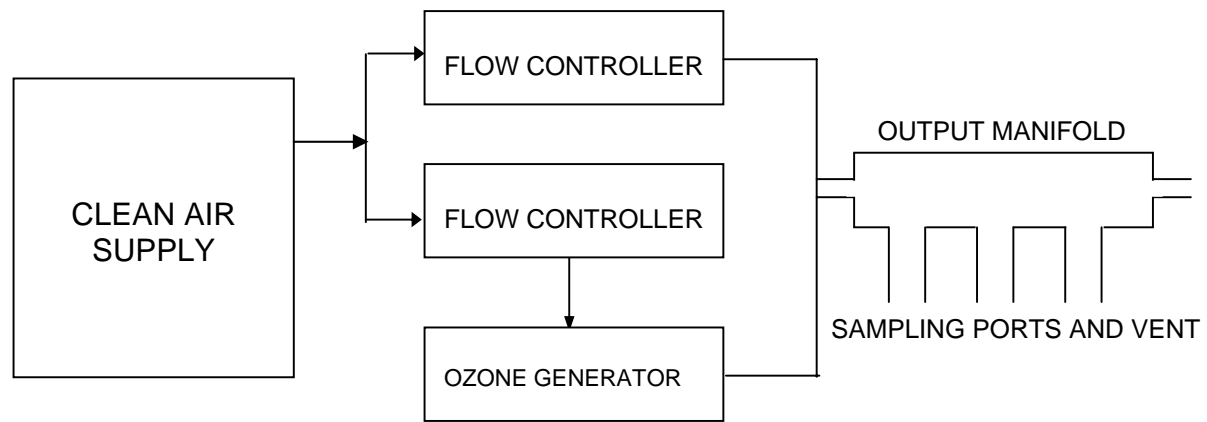

FIG: 3 OZONE SOURCE AND DILUTION SYSTEM.



## 9.0 REAGENTS

9.1 **Purity** - All reagents shall conform to specifications for reagent grade chemicals of the American Chemical Society.

9.2 **Zero Air** - Ambient air purified by passing through an activated charcoal filter, or by another appropriate manner (13).

## 10.0 PROCEDURE

10.1 Operate any commercial ozone analyzer following procedures given in the manufacturer's manual. Perform the calibration as directed in Section 11.0. Upon completion of a satisfactory calibration the analyzer is acceptable for ozone monitoring.

## 11.0 CALIBRATION

11.1 Connect the ozone analyzer to the output manifold of the calibration system (**Figure-3**). Check to insure proper operating parameters according to the instrument manual.

11.2 Connect either a UV photometer (Section 8.4.2) to the output manifold. Check to insure proper operating parameters according to the instrument manuals. Either of these instruments can determine the true ozone concentration of the calibration air streams.

11.2.1 As an alternative, the ozone concentration of the calibration air streams may be determined by using the Neutral buffered Potassium Iodide method.

11.3 **Zero Air** - With the O<sub>3</sub> lamp off, flush the system for about ten minutes to remove residual O<sub>3</sub>. While the analyzers sample the zero air, record ten consecutive digital display values. Calculate, for the ozone analyzer being calibrated and either the UV photometer or ozone transfer standard, the sum and average of the ten values and record. If an ozone transfer standard is used, note and record temperature and pressure.

11.3.1 If the spectrophotometric procedure is used, a manual sample of the zero air should be taken. Record the ppm of ozone found, performing the calculations described in the procedure.

11.4 **Test Atmospheres** - With the O<sub>3</sub> lamp well equilibrated, adjust the O<sub>3</sub> concentration to the range desired for a calibration point. Wait 10 minutes for equilibration at each setting. Measure and record the analyzer digital outputs as in the preceding Section 11.3. Test atmospheres of approximately 80, 60, 40 and 20% of the range of the analyzer should be run for a calibration.

11.4.1 If the spectrophotometric procedure is used, a manual sample is taken of each calibration point. Record the ppm of ozone found for each calibration level by performing the calculations described in the procedure.

## 12.0 CALCULATIONS

12.1 If a UV photometer was used in the calibration, the ozone readings are the true ozone concentrations already corrected to standard conditions (25°C and 101.3 kPa).

$$\text{True Ozone (ppm)} = \text{Ozone Reading} - \text{Zero Reading}$$

**Where :**

Ozone Reading = The UV photometer ozone readout for each calibration point test atmosphere (11.4)

Zero Reading = The UV photometer ozone readout for the zero air stream (11.3)

12.2 If a transfer standard was used in the calibration, its ozone readings must be corrected to standard conditions (25°C and 101.3 kPa).

$$\text{True Ozone (ppm)} = \left[ \text{Ozone Reading} - \text{Zero Reading} \right] \times \frac{P}{101.3} \times \frac{298}{t + 273}$$

**Where :**

Ozone Reading = the transfer standard readout for each calibration, point test atmosphere (11.4)

Zero Reading = the transfer standard ozone readout for the zero air stream (11.3)

P = the barometric pressure during the calibration in kPa (11.2)

t = the temperature during the calibration in °C (11.2)

12.3 If the spectrophotometric procedure was used in the calibration the true ozone is calculated as follows :

$$\text{True Ozone (ppm)} = \text{Ozone Conc.}_{\text{CTA}} - \text{Ozone Conc.}_{\text{ZAS}}$$

**Where :**

Ozone Conc.<sub>CTA</sub> = the ozone concentration calculated for each calibration test atmosphere (11.4.1).

Ozone Conc.<sub>ZAS</sub> = the ozone concentration calculated for the zero air stream (11.3.1).

**12.4 Instrument Calibration Curve** - Plot the net ozone analyzer outputs, i.e., each calibration point (11.4) less the zero air (11.3); versus the respective net true ozone readings from either 12.1, 12.2 or 12.3. If the average percent difference between the ozone analyzer observations and the true ozone concentration is within  $\pm 10\%$ , the analyzer is considered to be in calibration.

**13.0 REFERENCES**

1. INN, E.C.Y. AND Y. TANAKA. 1953. Absorption coefficient of Ozone as the Ultraviolet and Visible Regions. J. Opt. Soc. Am., 43:870.
2. HEARN, K.G. 1961. Absorption of Ozone in the Ultraviolet and Visible Region of the Spectrum. Proc. Phys. Soc., London, 78:932.
3. DEMORE, W.B. AND O. REAPER. 1964. Hartley Band Extinction Coefficients of Ozone in the Gas Phase and in Liquid Nitrogen Carbon Monoxide and Argon. J. Phys. Chem., 68:412.
4. GRIGGS, M. 1968. Absorption Coefficients of Ozone in the Ultraviolet and Visible Regions. J. Chem. Phys., 49:857.
5. BECKER, K.H., U. SCHURATH AND H. SEITZ. 1974. Ozone Olefin Reactions in the Gas Phase 1. Rate Constants and Activation Energies. Int'l Jour of Chem. Kinetics, VI:725.
6. CLYRE, M.A.A. AND J.A. COXON. 1968. Kinetic Studies of Oxyhalogen Radical Systems. Proc. Roy. Soc. A303:207.
7. SIMONS, J.A., R.J. PAUR, H.A. WEBSTER AND E.J. BLAIR. 1973. Ozone Ultraviolet Photolysis VI. The Ultraviolet Spectrum. J. Chem. Phys. 59:1203.
8. Operating and Instruction Manual, Dasibi Ozone Monitor, Model 1003 AH, Dasibi Environmental Corp., Glendale, CA.
9. CHERNIACK, I. AND R.J. BRYAN. 1965. A comparison Study of Various Types of Ozone and Oxidant Detectors which are Used for Atmospheric Air Sampling. JAPCA 15 (8):351.

10. California Air Quality Data, California Air Resources Board, Vol. XIII No. 1, January-March, 1981. p.3.
11. WENDT, J., J. KOWALSKI, A.M. BASS, C. ELLIS AND M. PATAPOFF. 1978. Interagency Comparison of Ultraviolet Photometric Standards for Measuring Ozone Concentrations. NBS Special Publication 529.
12. ALTSHULLER, A.P. AND A.F. WARTBURG. 1961. The Interaction of Ozone with Plastic and Metallic Materials in a Dynamic Flow System. Int'l. Jour. Air and Water Pollution. 4:70.
13. "Transfer Standards for Calibration of Ambient Air Monitoring Analyzers of Ozone", EPA 600/4-79-056 June 1979, Department E (MD-77) Research Triangle Park, N.C. 27711.
14. HODGESON, J.A., R.K. STEVENS AND B.E. MARTIN. 1972. A Stable Ozone Source Applicable as a Secondary Standard for Calibration of Atmospheric Monitors, pp.149-158. In Air Quality Instrumentation, Vol.1, John W. Scales, Ed. Pittsburg, Instrument Society of America.
15. "Technical Assistance Document for the Calibration of Ambient Ozone Monitors", EPA 600/4-79-057 July 1979, Department E (MD 77) Research Triangle Park, N.D. 27711.

[Continued](#)